



Evaluation of a Retrofit OH-58 Pilot's Seat to Prevent Back Injury

By

Joseph L. Haley, Jr.
COBRO Corporation

and

Ronald W. Palmer

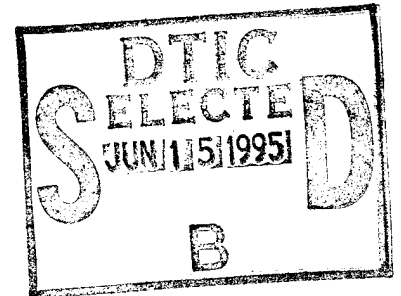

Aircrew Protection Division

December 1994

19950613 102

DTIC QUALITY INSPECTED 3

Approved for public release; distribution unlimited.

United States Army Aeromedical Research Laboratory
Fort Rucker, Alabama 36362-0577

Notice

Qualified requesters

Qualified requesters may obtain copies from the Defense Technical Information Center (DTIC), Cameron Station, Alexandria, Virginia 22314. Orders will be expedited if placed through the librarian or other person designated to request documents from DTIC.

Change of address

Organizations receiving reports from the U.S. Army Aeromedical Research Laboratory on automatic mailing lists should confirm correct address when corresponding about laboratory reports.

Disposition

Destroy this document when it is no longer needed. Do not return it to the originator.

Disclaimer

The views, opinions, and/or findings contained in this report are those of the author(s) and should not be construed as an official Department of the Army position, policy, or decision, unless so designated by other official documentation. Citation of trade names in this report does not constitute an official Department of the Army endorsement or approval of the use of such commercial items.

Human use

Human subjects participated in these studies after giving their free and informed voluntary consent. Investigators adhered to AR 70-25 and USAMRDC Reg 70-25 on Use of Volunteers in Research.

Reviewed:



KEVIN T. MASON
LTC, MC, MFS
Director, Aircrew Protection
Division

Released for publication:



ROGER W. WILEY, O.D., Ph.D.
Chairman, Scientific
Review Committee

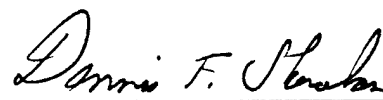

DENNIS F. SHANAHAN
Colonel, MC, MFS
Commanding

Unclassified

SECURITY CLASSIFICATION OF THIS PAGE

REPORT DOCUMENTATION PAGE				Form Approved OMB No. 0704-0188	
1a. REPORT SECURITY CLASSIFICATION Unclassified			1b. RESTRICTIVE MARKINGS		
2a. SECURITY CLASSIFICATION AUTHORITY			3. DISTRIBUTION / AVAILABILITY OF REPORT Approved for public release, distribution unlimited		
2b. DECLASSIFICATION / DOWNGRADING SCHEDULE					
4. PERFORMING ORGANIZATION REPORT NUMBER(S) USAARL Report No. 95-9			5. MONITORING ORGANIZATION REPORT NUMBER(S)		
6a. NAME OF PERFORMING ORGANIZATION U.S. Army Aeromedical Research Laboratory		6b. OFFICE SYMBOL (If applicable) SGRD-UAD-IE	7a. NAME OF MONITORING ORGANIZATION U.S. Army Medical Research and Materiel Command		
6c. ADDRESS (City, State, and ZIP Code) P.O. Box 620577 Fort Rucker, AL 36362-0577			7b. ADDRESS (City, State, and ZIP Code) Fort Detrick Frederick, MD 21702-5012		
8a. NAME OF FUNDING / SPONSORING ORGANIZATION		8b. OFFICE SYMBOL (If applicable)	9. PROCUREMENT INSTRUMENT IDENTIFICATION NUMBER		
8c. ADDRESS (City, State, and ZIP Code)			10. SOURCE OF FUNDING NUMBERS		
	PROGRAM ELEMENT NO.	PROJECT NO.	TASK NO.	WORK UNIT ACCESSION NO.	
	62787A	30162787A878	EA	138	
11. TITLE (Include Security Classification) Evaluation of a retrofit OH-58 pilot's seat to prevent back injury					
12. PERSONAL AUTHOR(S) J. L. Haley, Jr., and Ronald W. Palmer					
13a. TYPE OF REPORT Final		13b. TIME COVERED FROM _____ TO _____	14. DATE OF REPORT (Year, Month, Day) 1994 December		15. PAGE COUNT 75
16. SUPPLEMENTARY NOTATION					
17. COSATI CODES			18. SUBJECT TERMS (Continue on reverse if necessary and identify by block number)		
FIELD	GROUP	SUB-GROUP	crashworthy, pilot, seat design, copilot, helicopter pilot		
01	03				
05	09				
19. ABSTRACT (Continue on reverse if necessary and identify by block number) This report documents the development of pilot and copilot retrofit seats, flight tests and evaluation of the seats based on crash tests, flight tests, and a 5-year usage test in the USAARL OH-58, serial no. 71-207781. The Bell Helicopter Textron (BHT) designed seat consists of a new seat pan, hinged at the forward edge, and attached to "load-limit" devices at the rear edge. The seat will rotate about its forward edge mount and move downward approximately 5 inches at the rear edge when the impact sink speed of the helicopter is excessive. The 5-inch stroke of the seat occurs while sustaining approximately 12 G on a 50th percentile pilot (1500-lb maximum in the lower lumbar spine). The seats, mounted in a standard OH-58 fuselage, were subjected to simulated "sink" speeds of 26.5, 29.6, and 32.2 fps. The seats easily prevented "injury" to the dummy pilots at 26.5 fps, but the seats "bottomed" against the cyclic control yoke at greater sink speed. The prototype (pilot and copilot) seats added 43.5 pounds of weight to the OH-58, but <p style="text-align: right;">DTIC QUALITY INSPECTED 3 (Continued on next page)</p>					
20. DISTRIBUTION / AVAILABILITY OF ABSTRACT <input checked="" type="checkbox"/> UNCLASSIFIED/UNLIMITED <input type="checkbox"/> SAME AS RPT. <input type="checkbox"/> DTIC USERS			21. ABSTRACT SECURITY CLASSIFICATION Unclassified		
22a. NAME OF RESPONSIBLE INDIVIDUAL Chief, Science Support Center			22b. TELEPHONE (Include Area Code) (205) 255-6907	22c. OFFICE SYMBOL SGRD-UAX-SI	

19. Abstract (Continued).

suggestions are provided to reduce the weight addition to approximately 20 pounds for aircraft production seats. The noninjurious sink speed capability of the OH-58 is increased from approximately 15 fps to 27 fps by the incorporation of the simple seat design.

Contents

	Page
List of figures	2
List of tables	5
Introduction	7
Materials and test preparations	7
Crashworthy pilot's seat description	8
Seat test methods	9
Test results	9
Discussion of seat test results	18
Conclusions based on dynamic tests, BHT design effort, and flight evaluations	25
Recommendations	26
References	27
Appendixes:	
A - Crashworthy seat transducer results	60
B - List of Bell Helicopter Textron (BHT) engineering drawings used in the design, construction, and retrofit of OH-58 pilot and copilot seats	72
C - Executive Digest from TECOM Evaluation Report	73

Agreement For	
WHS GRAAI	<input checked="" type="checkbox"/>
DTIC TAB	<input type="checkbox"/>
Unannounced Justification	<input type="checkbox"/>
By _____	
Distribution/	
Availability Codes	
Dist	Avail and/or Special
A-1	

List of figures

Figure	Page
1. Civil Aeromedical Institute sled installed on acceleration track with OH-58 fuselage attached for pure vertical impact	29
2. CAMI sled installed on track with OH-58 fuselage attached for impact at 34 degrees from vertical	29
3. Fuselage attachment to CAMI sled (no scale)	30
4. Profile of seat assembly, left side shown	31
5. Profile of seat assembly, right seat shown	32
6. Frame assembly (armor encasement) installation	33
7. Five-point belt attachment to (1) armor plate frame and (2) canted bulkhead. Shows cushion after 1-inch width reduction to improve access to reel knob	34
8a. Hinge line bulkhead for seat pan forward edge support (strain gages on bracing tubes not shown)	35
b. Hinge line bulkhead for seat pan forward edge support (strain gage installation typical for three tubes)	36
9. Seat mount bulkhead (view looking aft) (Bell drawing 206-830-335)	37
10a. Wire bending (load-limiting) device used to "limit" the force transmitted to the seated pilot	38
b. Wire bending (load-limiting) device roller redesign	38
11. Integrated seat back and seat bottom cushion assembly (note contours at back and bottom)	39
12. Seat bottom support structure	40
13. Test setup for pure vertical crash vector--test 88057 (the aluminum channel and bracket used later for pilot display unit tests shown with "P")	41

List of figures (Continued).

Figure		Page
14.	Posttest view of test 88057 (note the stroked position of the bottom armor plate)	41
15.	Load cell force measured due to impact of the pivoting seat pan with the under-seat control yoke (see Figures 4 and 23)	42
16.	Measured helmet movement of right side dummy from film analysis and head deceleration (runs 88057, 88058, and 88059)	43
17.	Measured axial strain in aluminum bracing tubes and calculated loads	44
18.	Pretest view of test 88058 (note added beams below nose to stiffen the fuselage)	45
19.	Posttest view of test 88058 (note the stroked position of the bottom armor plate)	45
20.	Posttest view of test 88058, showing 95th percentile VIP dummy (note the .05-inch thick aluminum sheet used to stabilize the floor-to-bulkhead joint, and the slack in the wire bender at point "W")	46
21.	Pretest view of test 88059 (note the fuselage is pitched 56 degrees from vertical in lieu of 90 degrees)	47
22.	Posttest view of test 88059 (note slack wire bender device)	47
23.	Modeler's clay on underfloor yoke revealing the impact point of the left armor plate (note failure of BL 5.21 brace tube floor anchorage)	48
24.	Underfloor yoke impact at bottom armor plate near edge	48
25.	Failure of BL 20.3 right outboard brace tube anchorage to floor	49
26.	Posttest view of BL 17.5 left brace and BL 5.2 left brace tube (note slight separation of M535830 hinge at inboard edge)	50
27.	Failure of BL 17.5 left brace anchorage to floor	50

List of figures (Continued).

Figure		Page
28.	View of right seat area after removal of bottom armor plate at hinge (note separation of M535830 hinge at right end)	51
29.	Closeup view of BL 7.2 right anchorage failure at 1373 lb	51
30.	Calculated resultant of X, Y, and Z lumbar load cell vectors in right dummy	52
31.	Five-point restraint harness proposal (Pacific Scientific Company, or equivalent)	53
32.	View of small female pilot in Ser 71-20778 with five-point harness and seat pan BRP at 0.97-inch below sled test value (note collective in lowest position)	54
33.	View of seat back and bottom assembly in serial 70-20778	55
34.	View of tiedown strap exiting hole in seat bottom cushion	55
35.	Location of tiedown strap for five-point harness	56
36a.	Copilot seat bottom and back cushions after removal of PREQUAL™ cover after 20 months and 100 flight hours in JOH-58A (ser 71-20778)	57
b.	Copilot (left) seat bottom and back cushions (note disintegrated plastic lever supports)	57
37a.	Vertical seat adjustment concept to provide 1.8-inch BRP movement	58
b.	Seat adjustment concept details	59

Appendix figures

A-1.	Sled, seat, and dummy acceleration traces from test 88057	61
A-2.	Seat pan deflection and right dummy neck and lumbar force/moment from test 88057	62
A-3.	Head and pelvis accelerations of left dummy in test 88057	63

List of figures (Continued).

Figure	Page
A-4. Sled, seat, and dummy acceleration traces from test 88058	64
A-5. Seat pan deflection and right dummy neck and lumbar force/moment from test 88058	65
A-6. Head and pelvis accelerations of left dummy in test 88058	66
A-7. Neck forces and moments and lower lumbar resultant moment, right dummy, test 88058	67
A-8. Sled, seat, and right dummy acceleration traces	68
A-9. Seat pan deflection and right dummy neck and lumbar force/moment	69
A-10. Head and pelvis accelerations of left dummy	70
A-11. Neck forces and moments and lower lumbar resultant moment, right dummy, test 88059	71
C-1. The crashworthy seat and five-point restraint system (from TECOM #4AI-130-58A-023)	75

List of tables

Table	Page
1. OH-58 crashworthy seat test conditions	10
2. Crashworthy seat instrumentation	11
3. Summary of seat test results	12
4. Potential weight savings areas for production system	23

This page left blank intentionally.

Introduction

In response to the U.S. Army Medical Research and Development Command's broad agency announcement program, the Bell Helicopter Textron (BHT) Company submitted a proposal to the U.S. Army Aeromedical Research Laboratory (USAARL) to develop a new crashworthy pilot's seat for the OH-58 helicopter. In view of the pressing need for an improved seat to help prevent spinal column injuries in crashes (Robertson and Haley, 1969; Shanahan and Mastroianni, 1984), USAARL responded favorably to their proposal to develop and test a crashworthy seat for the OH-58 helicopter. USAARL contracted with BHT to develop a retrofit-type crashworthy pilot's seat under contract DAMD 17-87-C-7032. BHT developed the seat, monitored the conduct of crash tests, and installed these prototype seats in USAARL's flying OH-58A (aircraft serial no. 71-20778) in the September 1987 through December 1988 time frame. At the same time the retrofit pilot's seat design contract was under negotiation, the Office of the Program Executive Officer for Combat Aviation of the Army's Aviation Systems Command (AVSCOM) was developing an Air-to-Air Stinger (ATAS) pilot display unit (PDU). During an in-process Review (IPR) of the PDU in 1987, all participants agreed that several crash tests of the PDU, as installed on the OH-58, would evaluate the helmeted head strike hazard. Accordingly, AVSCOM agreed to furnish a single accident-damaged fuselage suitable for sled "crash" simulations for both the crashworthy seat and the PDU device. Thus, instrumented "dummy" pilots could be installed in the sled-mounted fuselage, and crash vectors applied to the sled so both the crashworthy seats and the PDU head injury potential could be evaluated with the same fuselage in a single test series. To this end, USAARL negotiated with the Federal Aviation Administration's Civil Aeromedical Institute (CAMI) to conduct and document the crash tests. The PDU test specimen and the OH-58 crashworthy pilot seat were to be provided by BHT. USAARL agreed to analyze the test data and provide a report. This report documents the seat evaluation while a separate report is in process for the PDU device.

Materials and test preparations

The CAMI impact sled and track are shown in Figures 1, 2 and 3. The sled is mounted on rollers and is accelerated along two tracks by a cable passing through several rollers and attached to an elevated mass. The decelerative "crash" is provided by sled contact with 0.25-inch diameter steel wires which are pulled around rollers anchored in the floor. The decelerative pulse shape is varied by the total number of wires and their placement along the track. This sled device is cheap, versatile, and provides repeatable pulses.

The helicopter nose section used in both the seat and PDU tests was excised from a damaged OH-58 fuselage. The structural rigidity of the cockpit was reduced because the crash-damaged windscreens/chin bubbles and cockpit doors were removed to facilitate testing. The fuselage was cut through the floor at the middle of the troop entry door and through the roof forward of the transmission mounts and the landing gear was removed before testing. The pilot seat bulkhead with shoulder strap guides and the upright center "box" beam were left intact. The

forward fuselage then was rigidly mounted to a horizontal "crash" sled with a belly-mount structure which could be oriented to provide the desired crash force vector (Figures 1, 2, and 3). The intent was to conduct six to eight crash tests up to a 28 G level without causing irreparable damage to the forward fuselage.

Crashworthy pilot's seat description

BHT conducted a preliminary design study to select the most feasible and practical OH-58 retrofit crashworthy seat for the Canadian Government's Defence and Civil Institute of Environmental Medicine (DCIEM) in 1987 (see Bell Helicopter Textron, 1987). The BHT-DCIEM study revealed a "pivoting seat pan" type seat to be superior relative to cost, retrofit ease, reliability, maintainability, weight, and development risk. USAARL agreed with the Canadian-funded study, and was positive toward the development of a prototype pivoting seat design. The prototype seat configuration finally developed and tested under this contract (DAMD 17-87-C-7032) is illustrated conceptually in Figures 4, 5 and 6. The right (pilot) seat and the left seat are identical in regard to basic functions, but the copilot's seat is 1.3 in shorter in the fore-aft length to clear the collective control tube during the downward stroking of the pan. Note the seat pan is fixed at the forward edge hinge point by a rugged piano hinge (Part MS35830). The seat pivots about this hinge under the resistance of the wire-over-roller load-limiting device until contact occurs with the under-seat control yoke. In Figure 4, the seat pan is shown in phantom lines in the deflected position. Note how the seat back cushion is connected to the seat pan cushion by a polycarbonate sheet to prevent the buttocks from contacting the bulkhead structure during downward movement. The lap belt is split into a yoke at either side of the hip and the yoke attaches at the seat pan and the rear bulkhead in a similar manner to the current seat (Figures 5, 6, and 7). The reinforcement of the existing honeycomb bulkhead that supports the forward edge of the seat pan is shown in Figures 8a and b. These figures also show the piano hinge attachment of the armor plate to the bulkhead. The bracing tubes added to the existing bulkhead also are shown at the right seat location. The bracing tubes were used at butt lines (BL) 5.2L, 7.2R, and 20.3R, but not at BL 17.5L due to clearance problems; a milled aluminum fitting (part 206-830-336-145) was used as detailed in BHT drawing 206-830-335. Strain gages were installed on the three bracing tubes, as seen in Figure 8b. The existing seat back bulkhead, serving as the support for the rear lap belt fittings and the "wire-bender" load-limiting devices, is illustrated in Figure 9. The "wire-bender" device is shown in Figure 10. The integrated seat back and seat bottom cushions are illustrated in Figures 11 and 12. Note the lever module support and woven nylon fabric cover provide good ventilation in the bottom cushion.

The seat design is described more fully in BHT Report 699-099-286 (Fox, 1988), including the load vs stroke data for the dynamic tests of the wire-bender "load-limiting" devices. If further details are desired, the list of BHT drawings used in the design, construction, and retrofit of these seats are at Appendix B.

Seat test methods

Both left and right seats were tested under three different decelerative crash pulses as shown in Table 1. Test variables included velocity, fuselage orientation, control yoke position, and applied decelerative pulse. A 50th percentile (Hybrid III) dummy was placed in the right seat while a 95th percentile (VIP) dummy occupied the left seat. Accelerometers (acceleration transducers) were mounted within the heads, chests, and pelvises of the dummies. A list of instrumentation used in the tests is at Table 2.

The position of the collective and cyclic control sticks determines the vertical position of the under-the-seat cyclic control yoke, and the yoke position dictates how far the seat armor plate moves downward before contact. The cyclic control stick was locked in the neutral position for all three tests, but the collective stick was locked "full-up" for the first test 88057, and "full-down" for tests 88058 and 88059. This location provided about 1-inch more buttock reference point (BRP) stroke for the first test (88057) than for tests 88058 and 88059.

Test results

The results are summarized in Table 3 which shows the fuselage orientation, velocity, sled peak G, seat pan peak G, seat pan stroke at the BRP* left dummy pelvis peak G, right dummy L4-L5 lumbar force, and right dummy chest peak G. The CAMI sled applied a horizontal deceleration parallel to the sled surface (see Figures 1 and 2), but the fuselage was pitched upward 90 degrees for tests 88057 and 88058 to simulate a z-axis impact vector. The fuselage was rotated 34 degrees forward for test 88059 to simulate a vertical impact combined with a forward (x-axis) impact which is typical in helicopter crashes, as discussed in volume I of the Army's Aircraft crash survival design guide (Desjardins et al., 1989).

Both the left and right crashworthy seats stroked (moved downward) as expected in all three tests. All transducer traces for these three seat tests are at Appendix A. The BHT Report No. 699-099-286 (Fox, 1988) includes a list of the peak readings from all transducers and is not repeated here.

* The buttock reference point (BRP) is a theoretical point below the hip hinge point for the resting (1G loading) at the cushion surface and buttocks contact as seen in Figure 5; the BRP is assumed at 10.2 inches rearward of the seat hinge for the 50th percentile male pilot placed flush against the seat back.

Table 1.

OH-58 crashworthy seat test conditions.

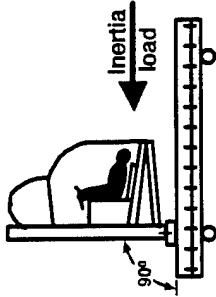
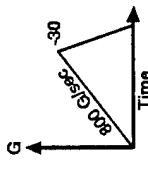
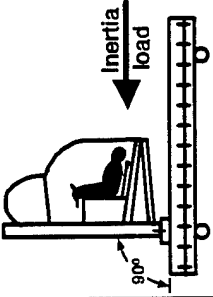
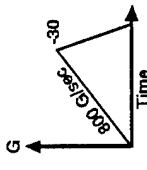
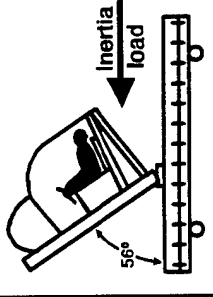
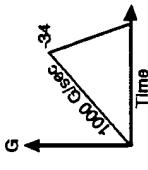
Test identity	Sled velocity (fps)	Fuselage orientation	Control yoke position	Applied pulse* (G-second)	Dummy identity size (percentile)	Comments
Pure vertical CAMI 88057	26.5		Neutral cyclic yoke (full-up collective) i.e., maximum stroke		Right, 50th % Hybrid III (175 lb) Left, 95th % V.I.P. (228 lb)	Dummies include triax acceleration at head, chest, & pelvis. Flight suit, SPH-4, leather boots & instrumentation included in weight. **
Pure vertical CAMI 88058	29.6		Full up yoke (full down collective) i.e., minimum stroke		Right, 50th % Hybrid III (175 lb) Left, 95th % V.I.P. (228 lb)	Dummies include triax acceleration at head, chest, & pelvis. Flight suit, SPH-4, leather boots & instrumentation included in weight. **
Vertical with 34° pitch CAMI 88059	32.2		Full up yoke (full down collective) i.e., minimum stroke		Right, 50th % Hybrid III (175 lb) Left, 95th % V.I.P. (228 lb)	Dummies include triax acceleration at head, chest, & pelvis. Flight suit, SPH-4, leather boots & instrumentation included in weight. ***

* Peak G values based on class 60 (100 Hz filter) per SAE J211.

** Pilot and copilot inertia reels set in automatic position.

*** Pilot and copilot inertia reels set in lock position.

Table 2.

Crashworthy seat instrumentation.

<ul style="list-style-type: none"> ◦ Sled X (resultant) acceleration (G) (two transducers for reliability) ◦ 50th percentile (Hybrid III) dummy transducers <ul style="list-style-type: none"> - Head X, Y, Z accelerometers and XYZ resultant calculation - Chest X, Z acceleration - Spinal column lumbar (L4, L5) load cell <ul style="list-style-type: none"> * X, Y, Z force in pounds (lb) * Moment about X, Y, & Z in inch-pounds (in-lb) ◦ 95th percentile (VIP) dummy transducers <ul style="list-style-type: none"> - Head X, Y, Z accelerometers and XYZ resultant calculation - Pelvis X, Y, Z accelerometers and XYZ resultant calculation ◦ Left inboard bracing tube strain gages (two axial) ~ micro-inches (μ in) ◦ Right inboard bracing tube strain gages (two axial) ~ micro-inches (μ in) ◦ Right outboard bracing tube strain gages (two axial) ~ micro-inches (μ in) ◦ Left seat pan deflection (Celesco rotary potentiometer (5 G extraction limit)) ◦ Right seat pan deflection (Celesco rotary potentiometer (5 G extraction limit)) ◦ Left seat Z acceleration (G) ◦ Right seat Z acceleration (G) ◦ Control tube force - lb (see Figure 15 for location) ◦ Right side profile camera at approximately 50 feet distance (1000 frames/sec) ◦ Right side profile camera at approximately 35 feet distance (500 frames/sec) ◦ Left side profile camera at approximately 35 feet distance (500 frames/sec) <p><u>Note:</u> Ektachrome reversal, type 7250, EP400 film. The filtering used for all transducers in these tests met the requirements of Society of Automotive Engineers (SAE) J211, "Instrumentation for impact test." Pertinent requirements are listed:</p>	
Typical test measurements - frequency response	Channel/class
CAMI sled and seat pan accelerometers	60
Lumbar and neck load cells, strain gages and deflection devices	60
Chest and pelvis accelerometers	180
Head accelerometers	1000

Table 3.

Summary of seat test results.

Test identity	Sled velocity (ft/sec)	Sled peak G	Left seat performance			Right seat performance				Comments:		
			Pan peak G @ BRP ^b	Stroke @ BRP ^b	Stroke @ seat rear edge	228-lb dummy	Pan peak G @ BRP ^b	Stroke @ BRP ^b	Stroke @ seat rear edge		175-lb dummy	
				B.H.T. calculation ^c	CAMI ^d measurements	Pelvis acceleration (G)		B.H.T. calculation ^c	CAMI ^d measurements	Lumbar L4-L5 force (lb)	Chest acceleration (G)	
Pure vertical CAMI 88057	26.5	-30	-21	5.61"	6.9"	16 G _x 5 G _y -44 G _z	-41	4.75"	4.8"	-333 _x -81 _y 148 _z and 1513 resultant	-8 _x -4 _z	Mild contact with underseat control yoke on left side
Pure vertical CAMI 88058	29.6	-30	-30	5.82"	7.1"	14 G _x 13 G _y -50 G _z	-46	4.82"	6.8"	-469 _x 49 _y 2125 _z and 2152 resultant	-12 _x -10 _z	Severe contact with underseat control yoke on left side. Control tube peak force was 2590 lb, see Figure 15.
Vertical with 34° pitch CAMI 88059	32.2	-34	-34	5.66"	7.8"	-17 G _x 10 G _y -53 G _z	-51	4.30"	6.6"	-242 _x 55 _y 1377 _z and 1379 resultant	-25 _x -6 _z	Moderate contact with underseat control yoke on left side. The four bulkhead brace-to-floor studs pulled out of the honeycomb floor, and the bulkhead hinge moved forward approximately 2-3 inches.

^a Force components measure by Denton load cell at L4-L5 vertebra in pelvis.

^b B.R.P. = buttock reference point assumed to be 10.2" from seat hinge.

^c Bell Helicopter Textron calculation based on wire Bender stroke.

^d Civil Aeromedical Institute measure via rotary potentiometer at rear edge of seat pan. These values probably are erroneous due to instrument inability to follow the high onset rate acceleration.

Test 88057 (pure vertical crash vector at 26.5 fps)

Pre- and posttest profile photographs are at Figures 13 and 14. All transducer traces for the test are at Figures A-1 through A-3. The right seat 50th percentile dummy stroked 4.75 in at the BRP, a point on the surface of the seat cushion located 5.75 inches forward of the seat reference point (SRP) with the cushion deflected under a 1 G load (see Figure 5). As shown in Table 3, the stroke of the seat was determined by BHT, based on the deformation of the wire bender which was replaced after each test; the seat BRP displacement also was measured directly by a CAMI rotary potentiometer with a quoted "5 G extraction limit." In this one case, the two methods agreed within experimental accuracy (4.75 and 4.8 inches), but the potentiometers showed excessive deflection in the other five readings shown in Table 3. The potentiometer output traces are shown in Figures A2, A5, and A9, and the probable potentiometer "overrun" points are shown on these traces. Since the seat pans were accelerated downward at 1000 G/sec up to a sustained 20 G level, it is clear that the "5 G extension" limit was exceeded, but the error appears to be related to rotational inertia of the device which permitted it to reel out excessive cable; the beginning of seat pan stroke agrees with film analysis and with dummy transducers.

The impact force caused by seat armor plate contact with the yoke was measured indirectly by placing a load cell at the top of the control tube as shown in Figure 15. The measured control tube forces in all three seat tests are illustrated in Figure 15. It is pertinent to observe in test 88057 that the relatively mild control force contact occurred at 90 ms as revealed by reference to Figure A-2 which shows the left seat reached 5.4-inch displacement (the left seat BRP stroke available up to yoke contact) at 90 ms time. Further evidence is gleaned from the z-axis acceleration of the left seat dummy's pelvis in Figure A-3 suddenly increasing from 15 G to 40 G between 91 and 94 ms; the left seat pan acceleration (Figure A-1) also shows a sudden increase from 10 G to 20 G in the same time span. The deceleration of the left seat pan reaches zero at 112 ms but the left pelvis deceleration is sustained through 140 ms and the left seat bracing tube sustains a load of 490 lb at 150 ms (Figure 17). This apparent anomaly probably is explained by the considerable stored energy in the seat cushion and dummy buttocks and spinal column causing compressive forces to remain in the seat cushion and dummy after seat pan downward motion ceases.

Note in Figure 16, which shows the right dummy's helmeted head movement, that the helmet displaced downward 7.2 inches, fully 2.4 inches more than the 4.8-inch movement of the dummy BRP; this difference is estimated as follows:

Helmet to head	=	0.2" from helmet internal compression
Hybrid III neck	=	0.2" from rubber vertebra compression
Thoracic vertebra	=	0.1" from metal and rubber vertebra compression
Lumbar vertebra	=	0.2" from rubber vertebra
Buttocks flesh	=	0.5" from sponge rubber compression
Seat cushion	=	1.0" from cushion compression
System elasticity	=	<u>0.2</u> " from wire bender elasticity and pan bending
Total BRP movement	=	2.4" addition to the seat stroke
BRP movement		

Although the above stored compressive energy is shown for the right dummy, the left dummy would be similar due to similar construction of dummy and seat cushion. The stored energy helps to explain why the control tube continues to show a force through 160 ms, but it is not clear why the control force peaked at 147 ms.

One would expect the force would become less after the pelvis z-deceleration reduces to zero at 140 ms. Of course, the 206-1b force is relatively small and could be caused by momentary friction of the dummy's back and thighs being squeezed between back and bottom cushions. Note in Figure A2 that the right dummy lumbar transducer shows over 600 inch-pounds of torque beyond 200 ms, indicating a relatively long duration force in both dummies.

The left seat BRP did stroke 5.61 inches, or 0.21 inch beyond the yoke contact point bending the yoke over its 2-foot span, but probably not exceeding its elastic limit.

This dynamic test definitely revealed the need to use the braces for the front bulkhead support. The strain in these braces was converted to load as follows (refer to Figure 8 for strain gage locations): The axial unit strain e , in the absence of torsional strain (bending strains were cancelled by symmetric gage placement), is equal to the stress in the tube divided by the tube modulus of elasticity, i.e., $e = \frac{S}{E}$,

where e = unit elongation or compression (inch/inch)
 $S = P/A = \text{load in lb} \div \text{cross section area (lb/in}^2\text{)}$
 $E = \text{ratio of stress to unit strain (lb/in}^2\text{)}$

and $A = .0786 \text{ in}^2$ for 3/4" outside diameter tube at .035" wall thickness.
 $E = 10.5 \times 10^6$ for drawn 2024-T3 tubing, reference MIL-HDBK-5.

Substituting P/A for stress into the above equation and solving for load yields $P = eEA$.

Inserting the appropriate values for AE and 600 microinch displacement yields a load of 495.2 lb.

$$P = (600 \times 10^{-6}) \cdot (10.5 \times 10^6) \cdot (0.0786) = 495.2 \text{ lb}$$

Thus, the above load is equal to each 600-microinch increment of strain in Figure 17 where all three bracing tube traces are shown on a common time base and all three tests are shown together. Observe the similarity of the load versus time variation of the three brace tubes; at 32 to 35 ms, all show a compressive load increasing to 500 lb each on the right seat, and 840 lb for the inboard brace of the left seat. The peak compressive load occurs exactly at 67 ms, then reduces to zero at exactly 74 ms, and continues to increase to a peak tensile load at 90 ms on the right seat with medium-size dummy and at 92 ms for the left large dummy. The 2-ms lag of the left seat also may be observed in the seat pan acceleration (Figure A1) in which the peak negative G of 20 and 22 G (left and right) begin to decrease at 103 and 101 ms. The right seat, right tube sustained 1735 lb compared to 1368 lb in the left; this difference would be expected since the center line of the right seat lap belt anchors is located about 0.7-inch outboard of the brace tube center line at BL 13.75R. The load in all three tubes reduces from their peak values to 500 lb or less at 117 ms; from 117 to 150 ms, the left seat sustains the load longer than does the right seat. This same extended time rebound force also is apparent in the left seat tube in the next two tests (88058 and 88059).

Test 88058 (pure vertical crash vector at 29.6 fps)

The only difference in this test and test 88057 was the increased velocity to 29.6 fps from 26.5, and the collective control being placed in the "full down" position yielding about 1 inch less available stroke before under floor yoke contact. Pre- and posttest photographs from the right side are at Figures 18 and 19. A posttest view from the left side is at Figure 20. All transducer traces for the test are at Figures A4 through A7.

Reference to Figure 15 shows the control tube force increased about 1 ms sooner than in test 88057, probably due to the lesser stroke available before yoke contact as shown in Figure A5 in the 82-85 ms time frame. Figure A5 also shows the right seat dummy's lumbar load cell overshoot from 1100 to 2125 lb between 85 and 95 ms, and Figure A4 shows both vertical seat pan transducers producing values of 30 and 45 G at about 92 ms. The control tube force peaked at 2590 lb at 104 ms, and then returned to zero at 134 ms, just about the time the left seat lumbar G value reduced to zero.

Table 3 shows the left seat BRP stroke to be 5.82 inches (BHT data) and the right seat to be 4.82 inches. Thus, the stroke was nearly equal to the stroke from the prior (lower velocity)

88057 test; i.e., only 0.14 inch more in this test in spite of the severe yoke contact indicated by the control tube sudden force increase between 85 and 104 ms. Since the sled input peak G was equal to test 88057, and the 11.7 percent velocity increase contained 24 percent more energy, the BRP strokes of both seats obviously were reduced due to the yoke impact. It appeared the yoke was bent downward a distance of 1.4-1.6 inch, but the amount of permanent deformation was not determined.

Again, film analysis of this test showed more downward movement of the helmeted head in Figure 17 than shown in Table 3 ($8.90'' - 4.82'' = 4.08''$). Although load-compression data for the seated 50th percentile dummy was not available for analysis, it is assumed the 4.08 inch compression occurred as was estimated in test 88057, except that incremental values were about 60 percent greater. The significance of this considerable compression in the dummy and seat cushion is the stored energy which tends to propel the dummy upward after the impact. The rebound webbing, shown in Figures 4 and 5, permitted the armor plate to rebound about 40 percent of the stroke as noted by Fox in BHT Report no. 699-099-286, pages 4-14. Fox also noted the spring-loaded cam on the webbing slide needed more pressure against the webbing, and the 2-foot long yoke beam, deflecting 1.4-1.6 inch, served as a flat spring being struck near its center; the writers concur with the BHT comments.

In summary, the second test (88058) with equal peak G and onset pulse, but 24 percent more velocity energy and less stroke before yoke impact, still was a qualified success. The left dummy sustained an average 25 G for 20 ms, the level of probable minor injury such as chip fractures or 10 percent compression of lumbar vertebra (Kazarian, and von Gierke, 1979). The right dummy sustained a force of 2000 lb for 6 ms with a peak of 2125 lb which may be compared to the 2500-lb peak dynamic "fracture value" shown by Kazarian and von Gierke to cause permanent compressive deformation of isolated lower lumbar vertebra.

This test showed definitely that excess crash energy does not result in a catastrophic effect, i.e., the armor plate to yoke impact still provides another 1- to 2-inch displacement (dependent on collective position) of increasing resistance. The resistance increased to 2590 lb over a 16 ms time span; this represents approximately a 1200-1800 G/sec onset rate for a 175 lb pilot. Of course, this test was conducted on an OH-58A model fuselage with the more flexible yoke than the ballistic resistant yoke used on C and D models, but the principle of a gradual force increase with seat "bottoming," based on the yoke's bending stiffness, continues to apply.

Test 88059
(vertical pulse with a 34-degree nose-down pitch)

The results of this test and prior tests 88057 and 88058 are summarized in Table 3. Note the fuselage is pitched "nose down" 34 degrees from the pure vertical crash vector. The "crash" velocity vectors are:

$$\begin{aligned} V_z \text{ vertical} &= 32.2 \cos 34^\circ = 26.7 \text{ fps} \\ V_x \text{ horizontal} &= 32.2 \sin 34^\circ = 18.0 \text{ fps} \end{aligned}$$

Note the vertical (z-axis) velocity is nearly identical to test 88057. The 34-degree pitch was used in lieu of a standard 30-degree value, per MIL-S-58095(AV) (Department of the Army, 1986), to offset the sled horizontal crash vector instead of a gravity drop test.

Pre- and postimpact photographs are at Figures 21 and 22. The steel tube running from the sled to the fuselage ceiling is shown clearly in Figure 22. This tube was intended to prevent horizontal shear deformation in the fuselage due to the horizontal crash loads.

The recorded transducer traces may be reviewed at Figures A-8 through A-11. The seat leading edge bulkhead braces at BL 17.5L, 5.2L, 7.2R, and 20.3R were torn free from their anchorages to the cockpit floor. The failures of these anchorages in the honeycomb floor were photographed and are shown in Figures 23 through 29. The stresses and corresponding loads in the three tubular braces are presented in Figure 17. The brace loads in this test are compared to those from the two pure vertical tests. Note an initial compressive load, due to the downward impact, did not occur in this test, and some tensile load appeared at 34 ms about the same time that the armor plate accelerometers showed deceleration (Figure A-8). The chest X deceleration of the right dummy (Figure A-8) peaked at 24 G, reflecting dynamic overshoot from the 34 G peak sled value acting at 34 degrees from the z-axis. The chest z-value, on the other hand, peaked at only 6 G, a value apparently incompatible with the known 12 G input to the buttocks as indicated by the 1300-lb load shown in Figure A-9. The same chest z-value was correspondingly too low in Figures A-1 and A-4 for tests 88057 and 88058, respectively. The chest z accelerometer appeared to have been inadvertently plugged into the y-axis chest accelerometer. This conclusion is based on the fact that the transducer also read very low negative and positive G in later PDU tests (runs 88060, 88061, and 88062), but when the cockpit was yawed 15 degrees for tests 063 and 064, the z-axis transducer came alive and displayed values of 10 to 15 G as would be expected for the y component. Thus, the chest z values shown are assumed to be chest y values.

The failure of all four brace anchorages at a horizontal velocity change of only 18 fps and approximately 20 G impact is a point worthy of redesign effort for a production seat. The right inboard (BL 7.2R) anchorage failed at only 1373 lb, little more than half the failure load of the other two tubes at 2203 lb $((2222+2184)/2)$. If failure had not occurred in the right inboard brace, and 2203 lb were sustained in each brace, the horizontal x-axis load would be as follows:

$$[2203 \text{ lb} \times 2 \times \sin 33^\circ = 2400 \text{ lb horizontal load per seat}]$$

Since the anchorages did fail after sustaining this force for about 10 ms (Figure 17), we believe only a small strength increase would sustain the test loads. It is suggested the horizontal shear be carried through the honeycomb "bathtub" at the outboard edges of each seat and at the center console web. The cost and weight of a web structure should be lower than the separate bracing tubes.

The movement of the helmeted head of the right dummy was analyzed from the two cameras on the right; the movement is illustrated to 1/8 scale in Figure 16. Note the 16-inch forward and 9.8-inch downward movement of the helmet even with a properly locked inertia reel, i.e., less than 3 inches strap movement from the reel.

Considering the vertical (z-axis) velocity change of 26.7 fps in this test (nearly identical to the 26.5 fps of test 88057), most z-axis transducers showed similar but slightly higher values due to the higher pulse onset rate and 12 percent higher peak G input. Both seat pan decelerations and left dummy pelvis were slightly higher but, surprisingly, all other readings were equal to or lower than the 88057 readings.

The control yoke was impacted at 76 ms as seen in Figure 15, but the control tube load cell sustained only 300 lb at 85 ms; this force was caused by the left dummy deceleration peak of 53 G at 82 ms (Figure A-10). Figure A-9 shows the left seat stroked beyond 5 inches at 80 ms, but "overran," as discussed already. Evidence of the left armor plate impact with the control yoke is shown in Figures 23 and 24. The control yoke was deflected approximately 1.5-inch after impact by the left armor plate, but the right armor plate only touched the yoke with no significant force transfer.

The failures of all four brace attachments to the "bathtub" honeycomb floor are depicted in Figures 25-29.

Discussion of seat test results

This was a successful test series both in terms of collecting pertinent transducer data and in the performance of the crashworthy seats. The key transducer to determine the seats' ability to "limit" load were the L4-L5 lumbar load cell in the right dummy, and the load cell output along the x-, y-, and z-axes are recorded at Figures A-2, A-5, and A-9. The x, y, and z resultant loads from all three tests are presented in Figure 30. Note the load was "limited" at about 1100 lb in test 88057, then peaked to 1500 lb. In test 88058, the excess energy caused the pivoting armor plate to impact the control yoke and peak at just over 2100 lb. In test 88059, the vertical (z-axis) velocity was about equal to that of test 88057, and the load was again "limited" to about 1150 lb over a time span of 25 ms. Although the right seat pan did impact the yoke in test 88059, it is

probable the heavier (228-1b) left dummy deformed the common control yoke downward early enough to prevent excessive force transmission to the right seat pilot. Thus, the pilot received a smooth ride at the expense of the copilot, i.e., the 1300-lb peak load (1150 lb average) was noninjurious as shown in Figure 30.

Considering the limited seat stroke (only 4.2 inches for a production seat) and considering the young, healthy pilots in the OH-58, we conclude the stroking level should be increased to 14.5 G, the same as the value used in the relatively noninjurious UH-60 pilot seats. A 14.5 G-limit in this test series would have permitted "no yoke impact" tests. This minimal change should be evaluated in a follow-on test program.

The x-, y-, and z-resultant head acceleration of the right dummy is presented along with the helmeted-head movement in Figure 16. The accelerations shown (up to 45 G) were sustained minus any helmet contact, and are to be expected for fuselage decelerations of 30 G, i.e., a dynamic overshoot of 50 percent.

As shown in Table 3, the seat is capable of a noninjurious loading for test 88057 at 26.5 fps, but the higher sink speed of test 88058 at 29.6 fps caused a minor injury loading. The right seat spinal lumbar load was noninjurious in test 88059, but the seat pan probably would have impacted the control yoke and caused a higher spinal loading if the left seat were unoccupied.

To summarize, the new crashworthy seat has demonstrated the ability to sustain a free-fall drop of 11 feet (height = $(26.5)^2 / 32.2$ (2)). The existing seat causes injury at free-fall drops greater than 3.5 feet (Robertson and Haley, 1969). Thus, a three-fold improvement in sink speed energy has been demonstrated.

If the under-the-floor yoke were redesigned to be more frangible or crushable, and to offer less resistance to the pivoting movement of the seat pan, the BRP stroke of a production design seat could be increased to 6.9 inches from 4.2 in an optimized design, one in which the control yoke thickness would be reduced to zero. A more realistic estimate would be 6.4 inches allowing 0.5 inch for the crushed thickness of a frangible yoke. Thus, the seat protective velocity could be increased to 30.0 fps from 26.5 or an increase to 14 feet free-fall height from 11 feet free-fall height (reference BHT Report 699-099-286, Figure 5-5). Obviously, the structural reliability and longevity of a newly-designed yoke should receive full consideration along with the ballistic tolerance capability and the crushability for crashworthiness. The 50 percent increase in seat pan stroke is a worthwhile goal and the cost to redesign the yoke to achieve the goal should be determined, but this seat design enhancement should not detract from the 300 percent seat improvement already demonstrated.

Flight test of crashworthy seats in JOH-58A
(serial no. 71-20778)

The crashworthy pilot seats were installed in USAARL's JOH-58A (serial no. 71-20778) in the July-August 1988 time frame, and a flight release was obtained from the U.S. Army Systems Command (AVSCOM) for the continuous use of the seats in this aircraft. USAARL requested the U.S. Army Test and Evaluation Command (TECOM) to conduct a suitability/compatibility evaluation of the seats installed in serial no. 71-20778. TECOM complied through their Aircraft Development Test Activity (ADTA) and conducted the evaluation under their Project No. 4-AI-130-58A-023 from January- March 1989. TECOM published an evaluation report entitled, Pilot compatibility and flight test of 0H-58 crashworthy seat, dated March 1989, written by Melvin Freitag and CPT Joe Ciampini.

Prior to the TECOM evaluation, USAARL replaced the existing copilot's restraint harness (3-inch wide belt with over-center lever buckle) with a 5-point restraint system. The 5-point system is less bulky, less stretchable under load, and weighs 2 lbs per seat less than the existing harness; the harness is detailed in Figure 31. The harness was installed in the left seat with a new dual-mode inertia reel, designed to lock at 1.5 G strap extension rate instead of the existing 2.5 G strap extension rate.

The "Executive Digest" from the TECOM evaluation report is reprinted as Appendix C. In addition to the TECOM digest, several other points from the report are worth mentioning.

- a. The 5-point shoulder strap lead-in to the inertia reel was too long. USAARL shortened the harness by 6 inches to the dimension shown in Figure 31 during the first week of the flight evaluation, and no further harness problems were noted.
- b. The 5-point harness reel lock-unlock handle could not be actuated easily due to the width of the seat bottom cushion. USAARL removed a 1-inch wide strip to provide more space for the actuation handle to move fore-aft between the cushion and the collective stick; the removed edge is shown in Figure 33.
- c. The TECOM flight evaluation used 10 pilots varying in sitting height from a small female (less than 1 percentile male sitting height), as shown in Figure 32, to a large male (over 95 percentile sitting height), based on the current pilot population). No significant problems were noted after (1) the shoulder strap was shortened, (2) the reel lock-unlock knob accessibility was improved by elevating the knob by 3/4 inch and reducing the width of the bottom cushion, and (3) the 5-point harness tie-down strap was routed through a hole in the cushion from an anchorage point on the armor plate forward edge, Figures 34 and 35.
- d. Two of ten pilots thought the lap straps should be easier to loosen following the initial cinching (snugging) after donning the 5-point harness.

After the TECOM evaluation was completed, the JOH-58A aircraft was returned to USAARL and this aircraft with the prototype crashworthy seats installed has continued to fly to the present. The left (copilot) seat still has the 5-point harness and the Pacific Scientific dual mode (1.5 G lock) inertia reel while the right seat includes the standard 4-point harness. The seats have continued to fulfill their function without complaint from the pilot users with one exception. The bottom "cushion" consisting of 30 plastic lever modules called PREQUAL™* and a ¼-in thick porous cover called SPACEFABRIC™*, degraded after approximately 20 months exposure at Fort Rucker, Alabama. Specifically, the SPACEFABRIC™ became threadbare and started unraveling, and the PREQUAL™ lost elasticity and the individual lever beams completely disintegrated, as shown in Figures 36a and b. The disintegration was far worse on the left seat, the side of the aircraft exposed to the sun most of the day during parking. We conclude the sunlight exposure probably had a greater degrading effect than did the heat since both left and right cushions received nearly equal heat in the closed cockpit. In BHT report 699-099-286, paragraph 3.2, the text indicated the PREQUAL™ levers were in use in the AH-1S helicopter on the SAVIM seats; thus, the longevity and wearability of the PREQUAL™ cushions with a sheepskin cover should be evaluated prior to production consideration for the OH-58.

The degraded PREQUAL™ was replaced with foam cushions (cut to size) from wrecked UH-60 seats, and the frayed, worn SPACEFABRIC™ was replaced with black sheepskin covers, also from UH-60 wrecked seats. A recent inspection reveals the seat cushions are still serviceable, but the sheepskin is faded somewhat after 4 years exposure in the JOH-58A. Unless SPACEFABRIC™'s resistance to sunlight is improved, the sheepskin material appears to be a viable candidate to replace it.

One final item about this seat design should be discussed prior to construction of a production item: the location of the BRP. Several publications have noted the lack of the OH-58 ceiling height to accommodate pilots beyond the 80th percentile seating height (Schopper and Cote, 1984, and Cote and Schopper, 1984). The sitting height of Army male pilots, as stated in Natick TR-91-O4O, page 249 (Donelson and Gordon, 1991) is:

5th percentile 34.34"
25th percentile 35.76"
50th percentile 36.65"
75th percentile 37.48"
80th percentile 37.69"
85th percentile 37.92"
90th percentile 38.22"
95th percentile 38.66"

* Reference BHT drawing 206-078-376

The USAARL JOH-58A has the BRP at waterline (WL) 33.60, as previously discussed, but USAARL recommended the BRP be lowered to WL 32.26 to provide cockpit accommodations to agree with MIL- 5TD-1333. This standard specifies pilot vertical space as follows:

<u>Height and distance</u>	<u>OH-58 Waterlines (WL)</u>
Distance from floor to BRP * = 11.26"	21.00 inside floor level
95th % sitting height above BRP = 38.66"	32.26 Buttock reference point level *
SPH-4 helmet thickness = 0.96" **	71.88 top of helmet and bottom of canopy
Plexiglass thickness = 0.12"	72.00 outside cockpit surface

* The BRP is the assumed center of pressure of the buttocks on the seat surface; BHT shows the BRP to be 5.75" forward of the seat reference point (SRP) the point of intersection between the seat bottom as shown in Fig 5. We concur with the BRP location.

** This is the minimal helmet thickness with the thermoplastic liner (TPL™) or sling at minimum thickness.

Obviously, the dimensions are applicable only with zero clearance from helmet to bottom of plexiglass, and with a minimal offset "low fit" helmet, but the dimensions would allow up to the 95th percentile pilots to comfortably fly the helicopter; we are aware that pilots can "slump down" and lose 2 inches sitting height so that some 95th percentile pilots currently fly the OH-58. Nonetheless, prudent safety officers must wonder about 2-hour flights where pilots never can sit up straight.

Designing the BRP at WL 32.26 is 2.31 inches below the level used in the CAMI tests at BRP=34.57. Since the available stroke on the copilot seat was 5.4 inches, the percent loss of stroke is:

$$\frac{2.31}{5.4} \times 100 = 42.8\%$$

To offset this stroke loss, it is recommended the wire benders be changed to a 14.5 G design from a 12 G value to decrease the stroke needed by 39.3 percent (based on CSDG 89-22 calculations) so that only 3.5 percent or 0.19 inches stroke would be lost. No further rationale to justify the change to 14.5 G from 12 G is presented since the 14-year successful use of a 14.5 G pilot's seat in the UH-60 helicopter is adequate, especially in view of the limited stroke available in the OH-58. One other point to mention is the possibility that the current cushion thickness of 1.5 inches could be reduced toward 1.0 inch, which is the value stated to be used in the SAVIM seat in the AH-1 helicopter. The PREQUAL™ lowest tier of lever beams is 0.45-inch thick and appears to provide only 0.1 inch of elastic movement. Removal of this tier appears feasible with little effect on comfort.

Suggested weight saving ideas for a
production seat installation

Fox (1988) discusses saving weight in Bell Helicopter Textron Report 699-099-286, paragraph 5.5. We concur with the 23-1b saving shown in Table 5-5. This table is reprinted for easy reference.

Table 4.

Potential weight savings areas
for production system.

Design area		Savings/aircraft
Item	Potential weight savings action	Lbs (kg)
1.	Armor panel support structure - Go back to honeycomb panel	8.4 (3.8)
2.	Armor panel - Go back to original coverage	1.31 (0.6)
3.	Seat pan hinge of steel plates & pin - Go to sheet metal hinge	3.08 (1.4)
4.	Seat cushions with improved comfort & adjustable lumbar support - Go back to original OH-58 tube/ netting seats	6.96 (3.2)
5.	Seat back bulkhead web - Go back to existing 0.020 in (0.09 cm) thickness with lightening holes	1.91 (0.9)
6.	Knee bulkhead structure - redesign without bolted on plate	<u>1.44 (0.6)</u>
	Total	23.1 (10.9)

* Note: Adaped from Bell Helicopter Report No. 699-099-286, Table 5-5 (Fox, 1988)

USAARL recommends several other changes to the BHT table above to take off weight and to add weight as follows:

<u>Item</u>	Weight difference (pounds)
#4. Seat cushions	-2.0 (thigh support reduction)
TECOM flight evaluation praises new PREQUAL™ support; thus, request PREQUAL™ be constructed of more sun-resistant plastic or sheepskin to be used as the cover. Suggest the movable lumbar pad be approximately 1/2-inch thicker and integrated into the back cushion. Also suggest thigh support be 1.3 inch thick in lieu of 1.8 inch thick.	+6.96 (use contoured cushions)
#6. Delete floor-to-bulkhead braces at BL 17.5L, 5.2L, 7.2R, and 20.3R and replace with horizontal beam between knee bulkhead and FS 73.06 canted bulkhead.	-2.0 (approximately)
#7. Change to 5-point restraint harness (2 each).	-4.0
#8. Redesign wire bender as shown in Figure 10 to improve fatigue life of wire, based on experience with UH-60 troop seat wire benders.	zero
#9. Add 2.0 inch vertical adjustment to change BRP from WL 32.26 to WL 34.26 (0.66 inch above the existing fixed BRP of standard seat).	+2.0*
Total saving =	-0.96 (say 1.0)

* Exact weight increase awaits a detailed design, but a simple device (as shown in Fig. 37) will add approximately 2 lb (i.e., 1 lb per seat).

We have shown the potential to reduce the weight by 1 lb over that shown by BHT in Table 5-5. Thus, the total weight saving could be 24 lb and, subtracted from 43.5 lb for the prototype, would yield a weight increase of only 19.5 lb.

The seat adjustment feature would add 2 lb, but the weight penalty is considered negligible considering the improved comfort for the OH-58, the only Army helicopter without this feature in the active Army inventory. The seat adjustment design idea shown in Figure 37 assumes a preflight seat adjustment to three positions.

Conclusions based on dynamic tests, BHT design effort, and flight evaluations

1. The technical feasibility and practicality of a retrofit-type crashworthy seat have been demonstrated.
2. Based on quasistatic level of 12 G_z on a 50th percentile male pilot, the seat prevented injury (due to excessive vertical forces) at a sink speed of 26.5 fps; this level of crash energy is approximately three times that of the existing seat, i.e., 11.0-foot drop height versus 3.5-foot drop height.
3. The BRP on the pilot's seat cushion can be lowered 2.3 inches below that used in the dynamic tests, providing for a 95th percentile pilot sitting upright, and still provide protection up to 26.1 fps if the vertical G_z level is increased to 14.5 from 12.
4. The stroke of the seat pan can be increased about 50 percent by replacing the existing rigid under-seat cyclic "yoke" with a thin-walled (crushable or frangible) yoke to permit penetration or easy crushing; this change would increase the seat's protective capacity to a 14-foot drop height from a 11-foot drop height, and increase protection to the 95 percentile accident from the 93.5 percentile survivable accident.
5. A production crashworthy seat (two each) probably can be retrofitted with a weight penalty of only 20 lb per aircraft.
6. The crashworthy seat was rated more comfortable than the existing seat by the flight test pilots.
7. The third impact test, no. 88059, with a vertical and rearward impact vector, showed a helmeted head displacement of 16 inches. This left little doubt about the need for good helmet fit and retention; a slight sideward impact vector in this test would have caused helmet contact with the door frame.
8. The geometry of the split-end (yoke) lap belt, with one end attached at the rear vertical bulkhead and the other end anchored at the seat pan, worked as desired, providing snug restraint throughout the seat stroke.

9. Incorporation of a vertical seat adjustment feature appears to be relatively easy in this hinged seat design, and its use would permit a 95th percentile pilot to sit up straight in the OH-58 cockpit.

Recommendations

1. A hinged crashworthy seat as described in this report be installed in all OH-58 aircraft; the seat should include the following specifications and features:

a. The quasistatic "limit stroking" value to be 14.5 G acting on a 50 percentile pilot (174.44 lb + helmet, flight suit, and boots = 182 lb).

b. Vertical adjustment of BRP of 1.8 inches to be incorporated with a simple device, i.e., adjustment during flight not necessary.

c. The BRP be located at WL 32.26 to provide for a pilot sitting height of 38.66 inches (95th percentile); with the adjustment device added, the BRP shall be raised to 32.26 + 1.8 in to WL 34.06.

d. A lightweight (2.8 lb), 5-point harness, equivalent to the one shown in Figure 31 be provided to replace the current 4.6-lb harness.

e. A minimum radius of 0.38 inch be used for all stressed "load-limiting" wire in lieu of the 0.30 inch used in the prototype, as shown in Figure 10b.

f. The slope of the seat pan thigh surface shall fall between 5 and 15 degrees.

2. Research be initiated to determine the cost effectiveness of redesigning the cyclic yoke to provide "crushability" during seat pan displacement.

3. A joint program be considered with the Canadian Armed Forces to develop the seat recommended in paragraph 1 to achieve the lowest cost.

References

- Bell Helicopter Textron, Inc. 1987. In-process review of 0H-58 pilot display unit. Fort Worth, TX: Bell Helicopter Textron.
- Bell Helicopter Textron. 1987. Investigation of improvements in vertical impact crash protection for CH-136 Kiowa aircrew. Ste-Therese, Quebec, Canada: Bell Helicopter Textron. BHT Report CR:87:ST:02.
- Cote, David O. , and Schopper, Aaron W. 1984. Anthropometric cockpit compatibility assessment of U.S. Army aircraft for large and small personnel wearing a cold weather, armored vest, chemical defense protective clothing configuration. Fort Rucker, AL: U.S. Army Aeromedical Research Laboratory. USAARL Report No. 84-11.
- Department of the Army. 1986. Seat system: Crashworthy, non-ejection, aircrew. U.S. Army Aviation Systems Command. Military specification: MIL-S-58095(AV).
- Desjardins, S. P., Zimmermann, Richard E., Bolukbasi, O., and Merritt, Norman A. 1989. Aircraft crash survival design guide. Vol IV - Aircraft seats, restraints, litters, and cockpit/cabin delethalization. Fort Eustis, VA: U.S. Army Aviation Research and Technology Activity (AVSCOM). USAAVSCOM TR 89-D-22D. Volume IV of five-volume report.
- Donelson, Sarah M. , and Gordon, Claire C. 1991. 1988 anthropometric survey of U.S. Army personnel: Pilot summary statistics. Natick, MA: U.S. Army Natick Research, Development and Engineering Center. NATICK TR-91/O4O.
- Fox, Roy. 1988. 0H-58 energy-attenuating crew seat feasibility study. Fort worth, Tx: Bell Helicopter Textron, Inc. BHT Report 699-099-286.
- Freitag, Melvin, and Ciampini, Joe. 1989. Pilot compatibility and flight test of 0H-58 crashworthy seat. Fort Rucker, AL: u.S. Army Test and Evaluation Command (TECOM), Combat Air- craft Test Division, ADTA. Project No. 4-A1-130-58A-023.
- Kazarian, Leon E., and von Gierke, Henning E. 1979. The validation of biodynamic models. AGARD Proceedings CP253, Paper A13, Figure 1. London, England.
- Robertson, S. H., and Haley, J. L. , Jr. 1969. Crash survival evaluation of the 0H-58 helicopter. Fort Eustis, VA: USAAVLABS. AvSER Memo Report 69-6.

References (Continued).

Schopper, Aaron W., and Cote, David O. 1984. Anthropometric cockpit compatibility assessment of u.s. Army aircraft for large and small personnel wearing a training, warm-weather clothing configuration. Fort Rucker, AL: U.S. Army Aero- medical Research Laboratory. USAARL Report No. 84-10.

Shanahan, Dennis F., and Mastroianni, George R. 1984. Spinal injury in a U.S. Army light observation helicopter. Aviation, space, and environmental medicine. 55(1):32-40.

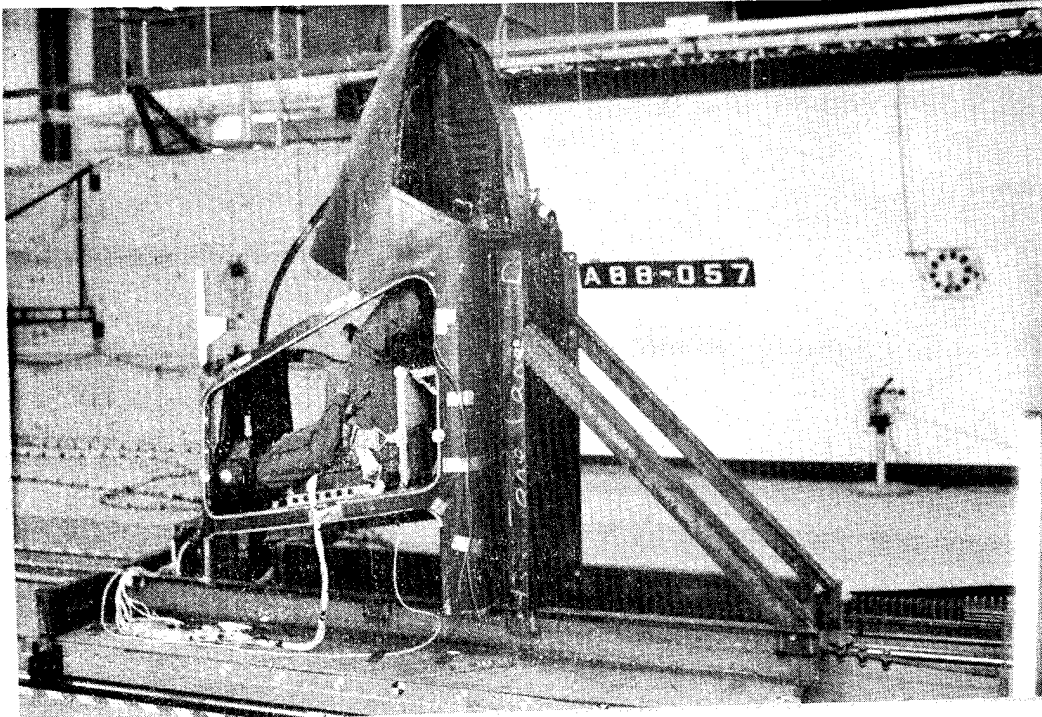

Figure 1. Civil Aeromedical Institute sled installed on acceleration track with OH-58 fuselage attached for pure vertical impact.

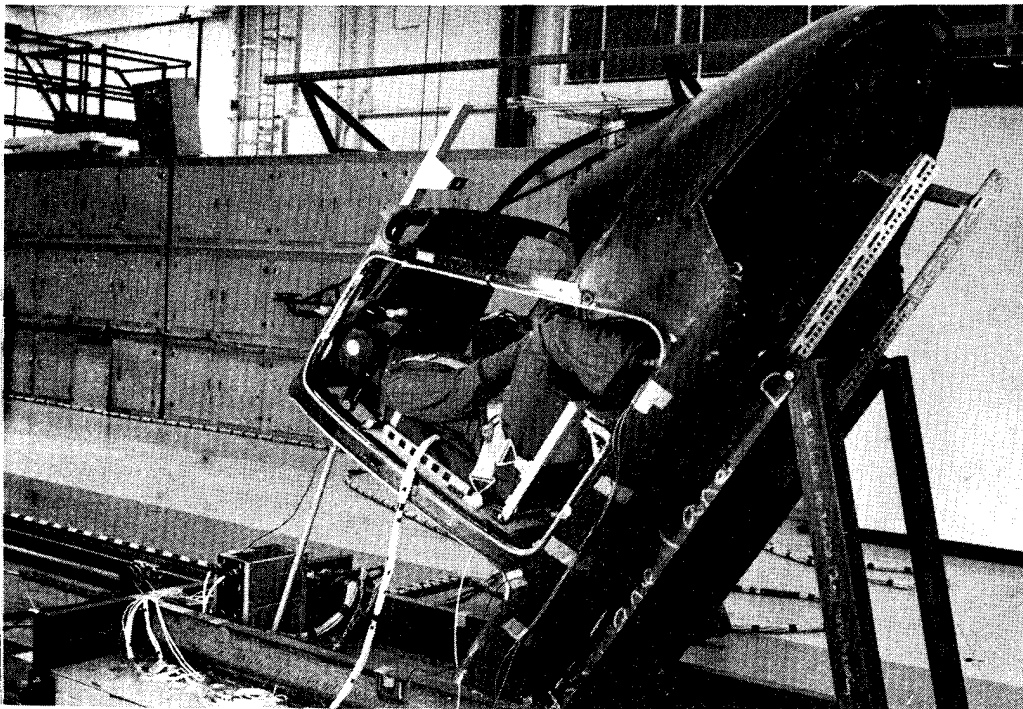

Figure 2. CAMI sled installed on track with OH-58 fuselage attached for impact at 34 degrees from vertical.

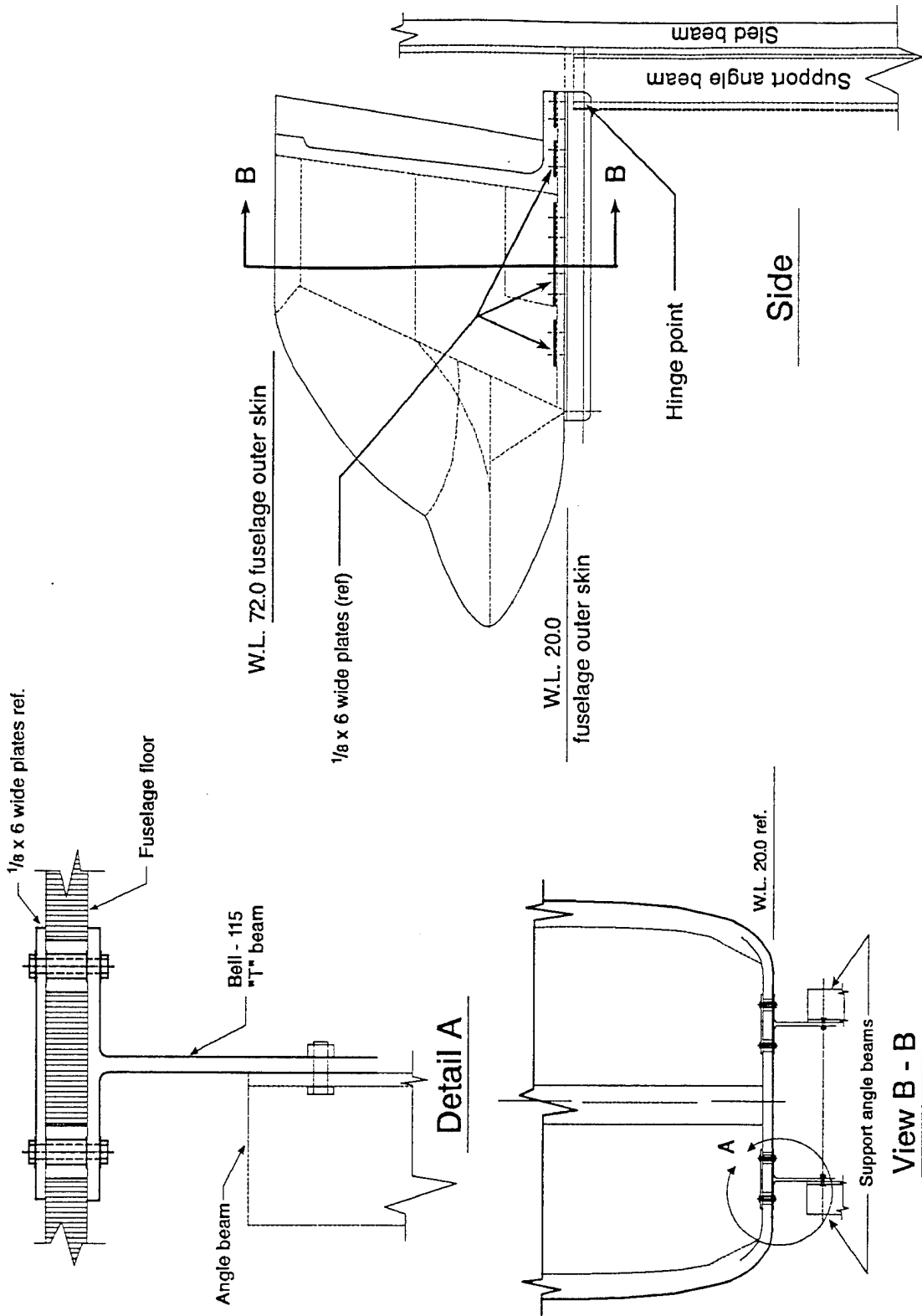

Figure 3. Fuselage attachment to CAMI sled (no scale).

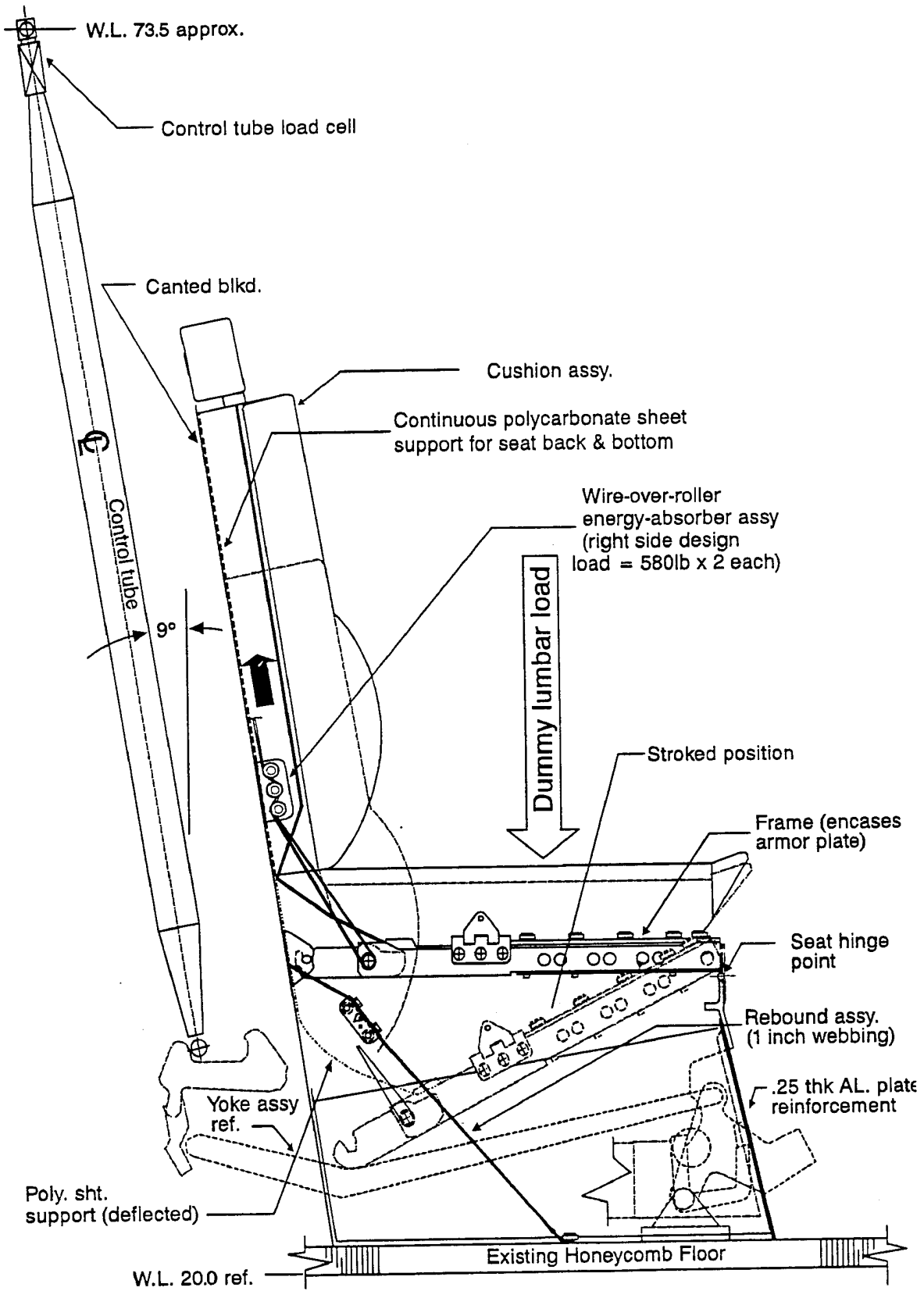

Figure 4. Profile of seat assembly, right seat shown.

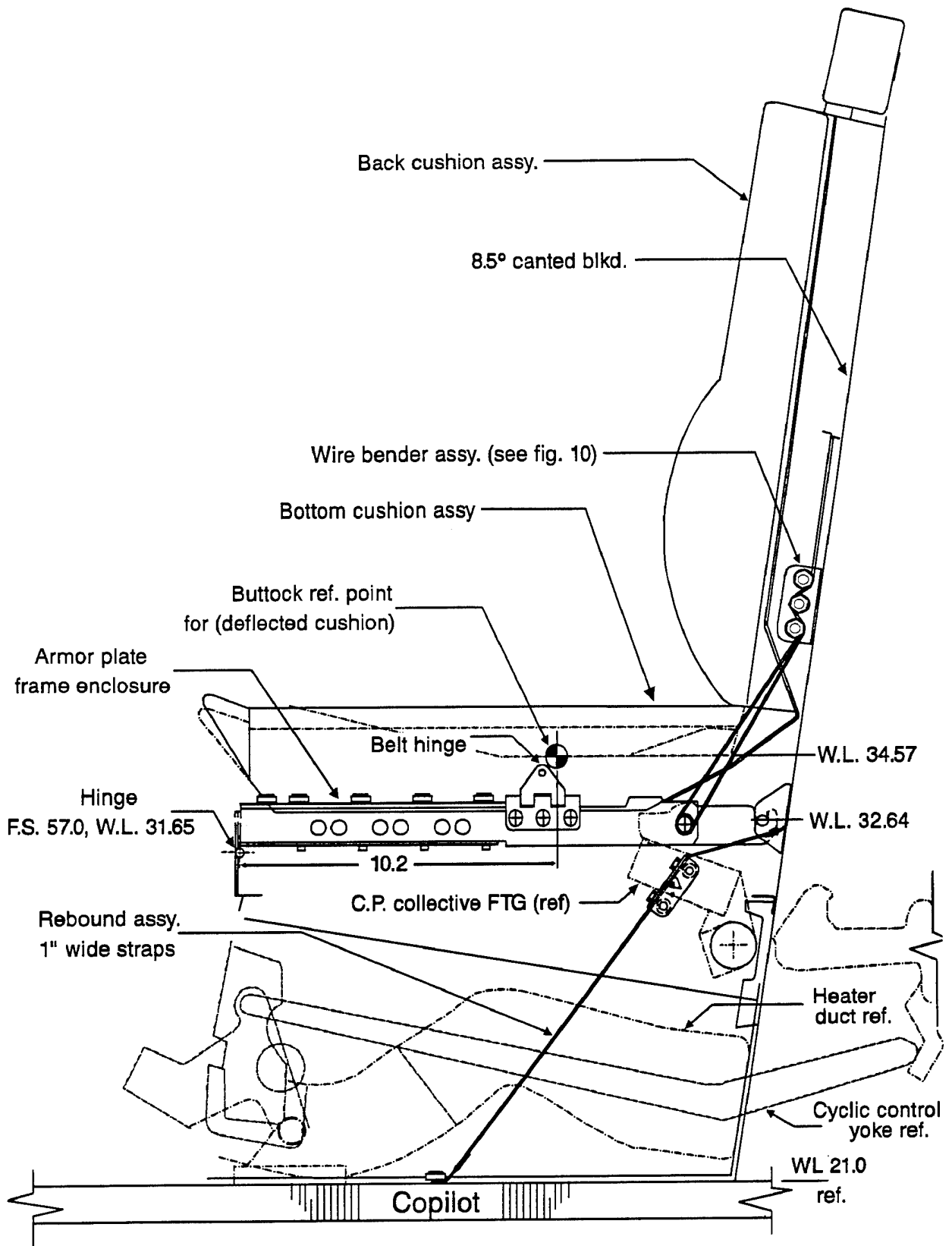

Figure 5. Profile of seat assembly, left side shown (note armor plate usage as a pivoting pan).

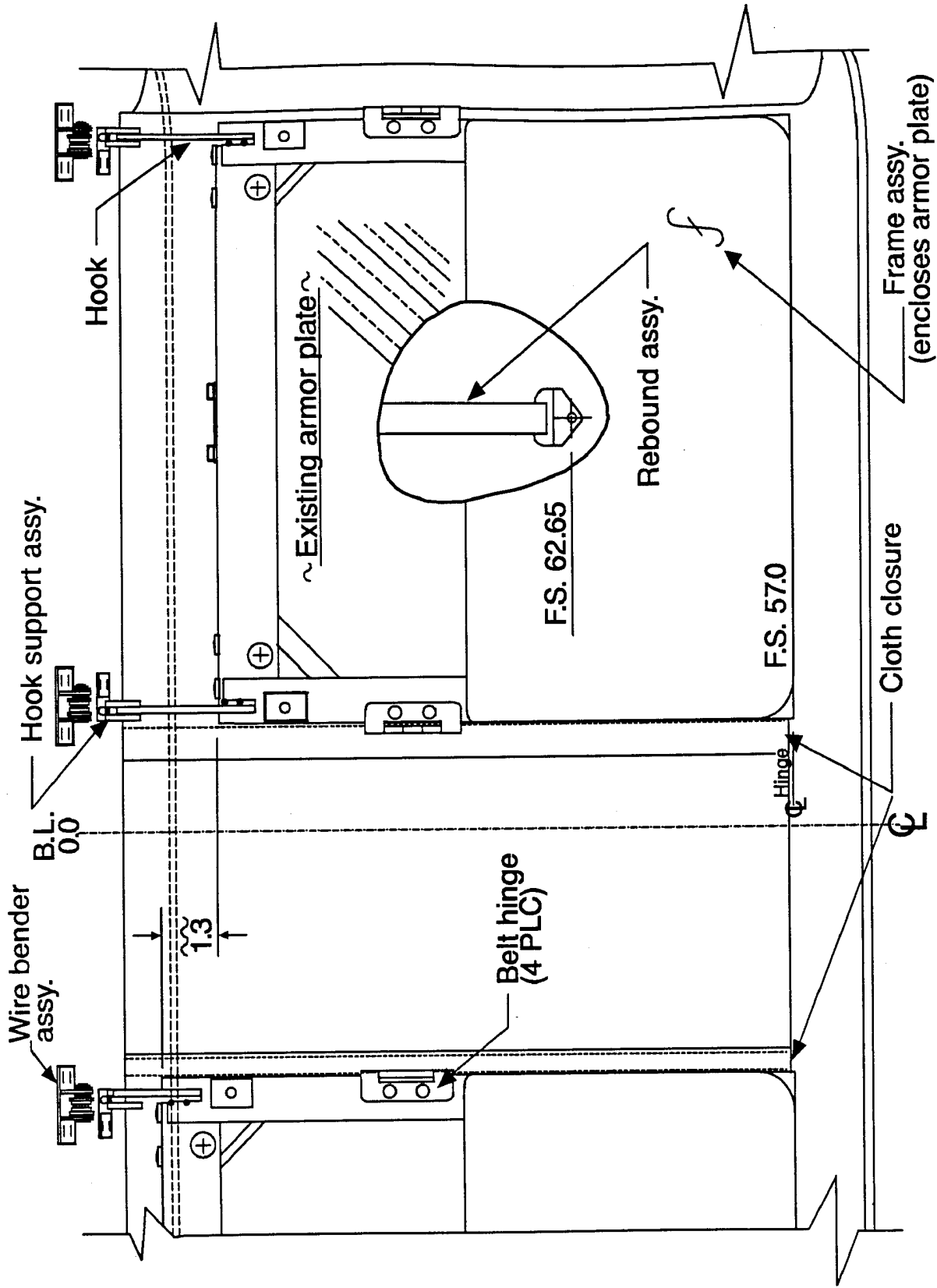

Figure 6. Frame assembly (armor encasement installation).

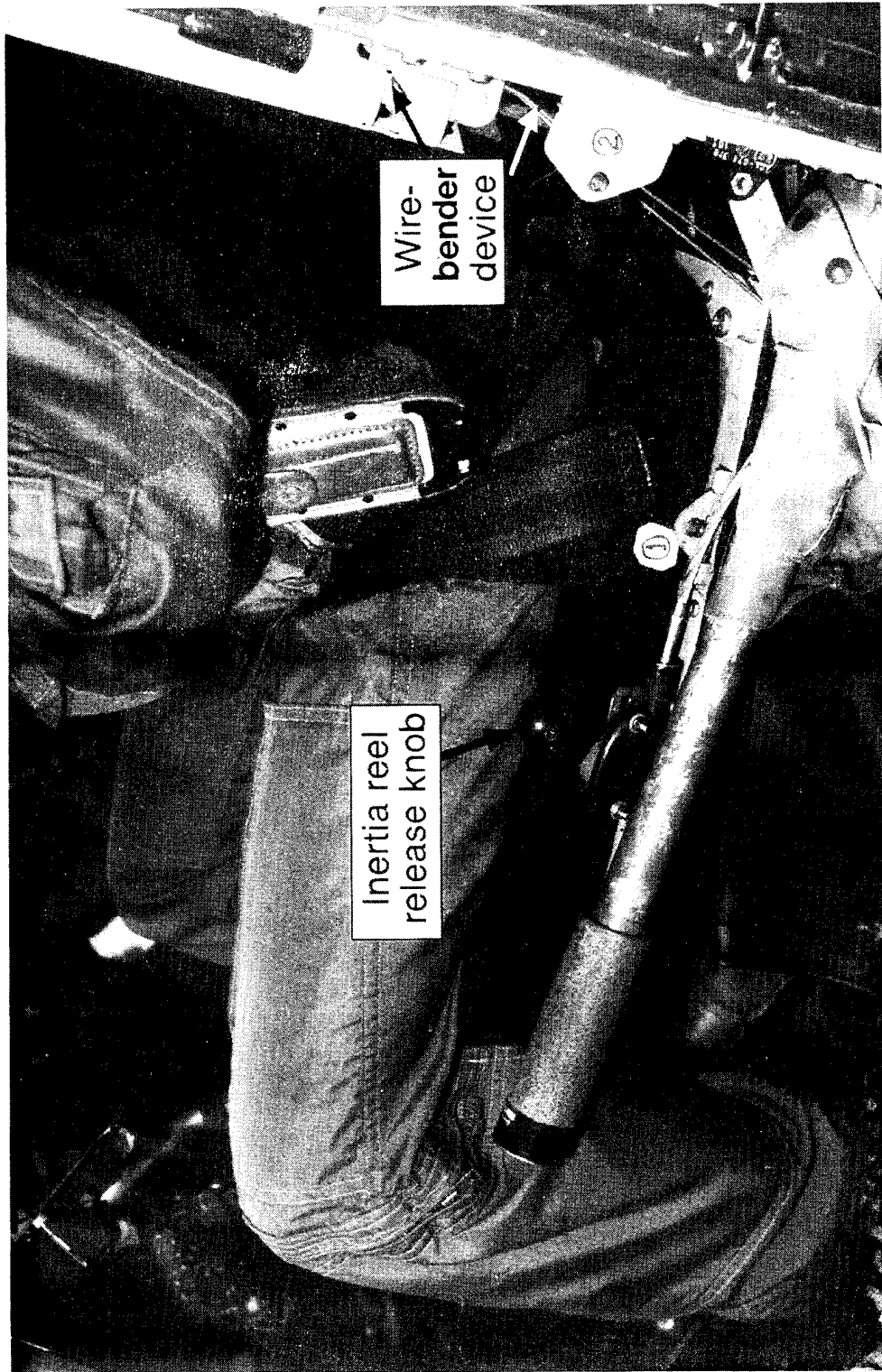
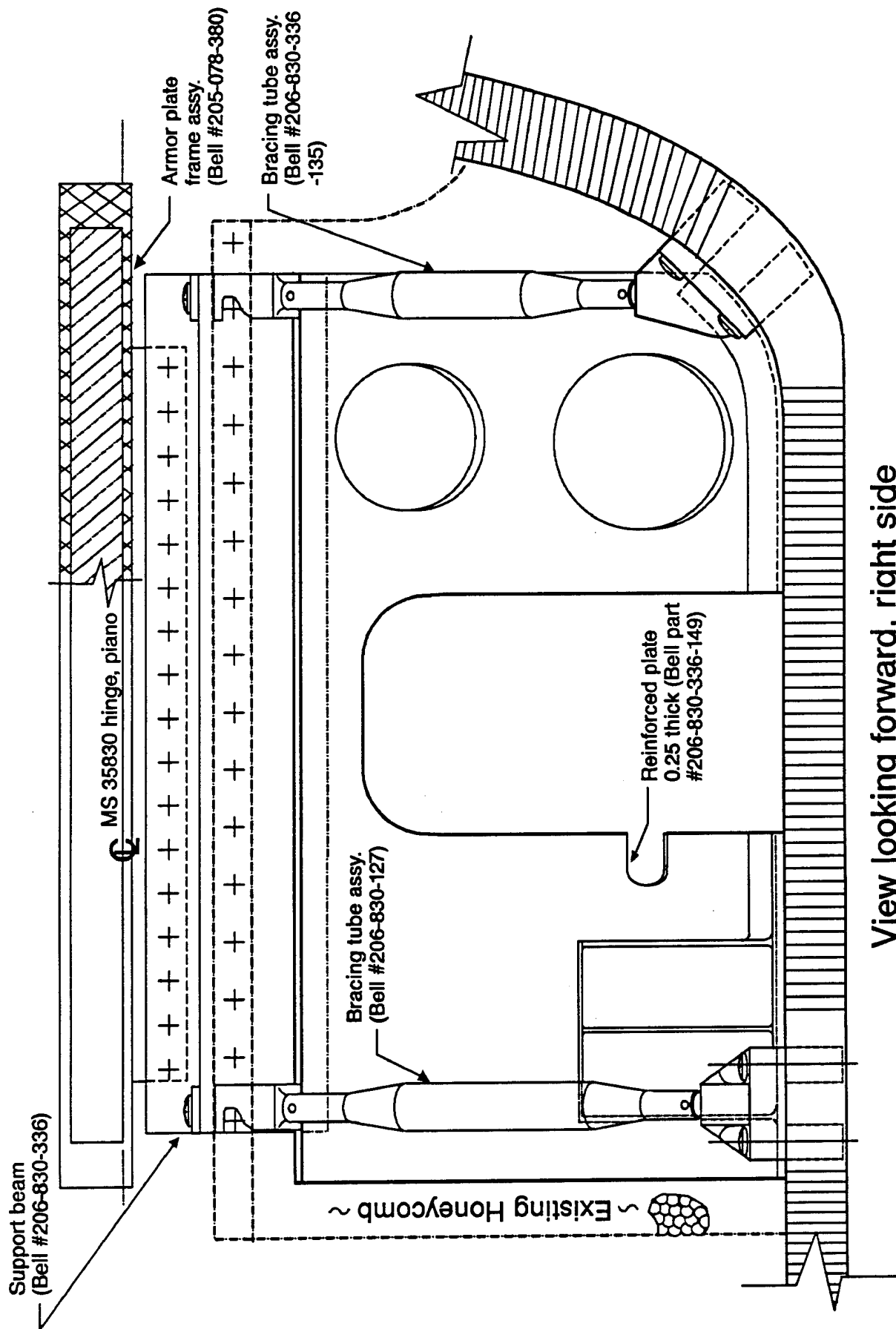

Figure 7. Five-point belt attachment to (1) armor plate frame, and (2) canted bulkhead. Shows cushion after 1-inch width reduction to improve access to reel knob.



View looking forward, right side

Figure 8a. Hinge line bulkhead for seat pan forward edge support (strain gages on bracing tubes not shown).

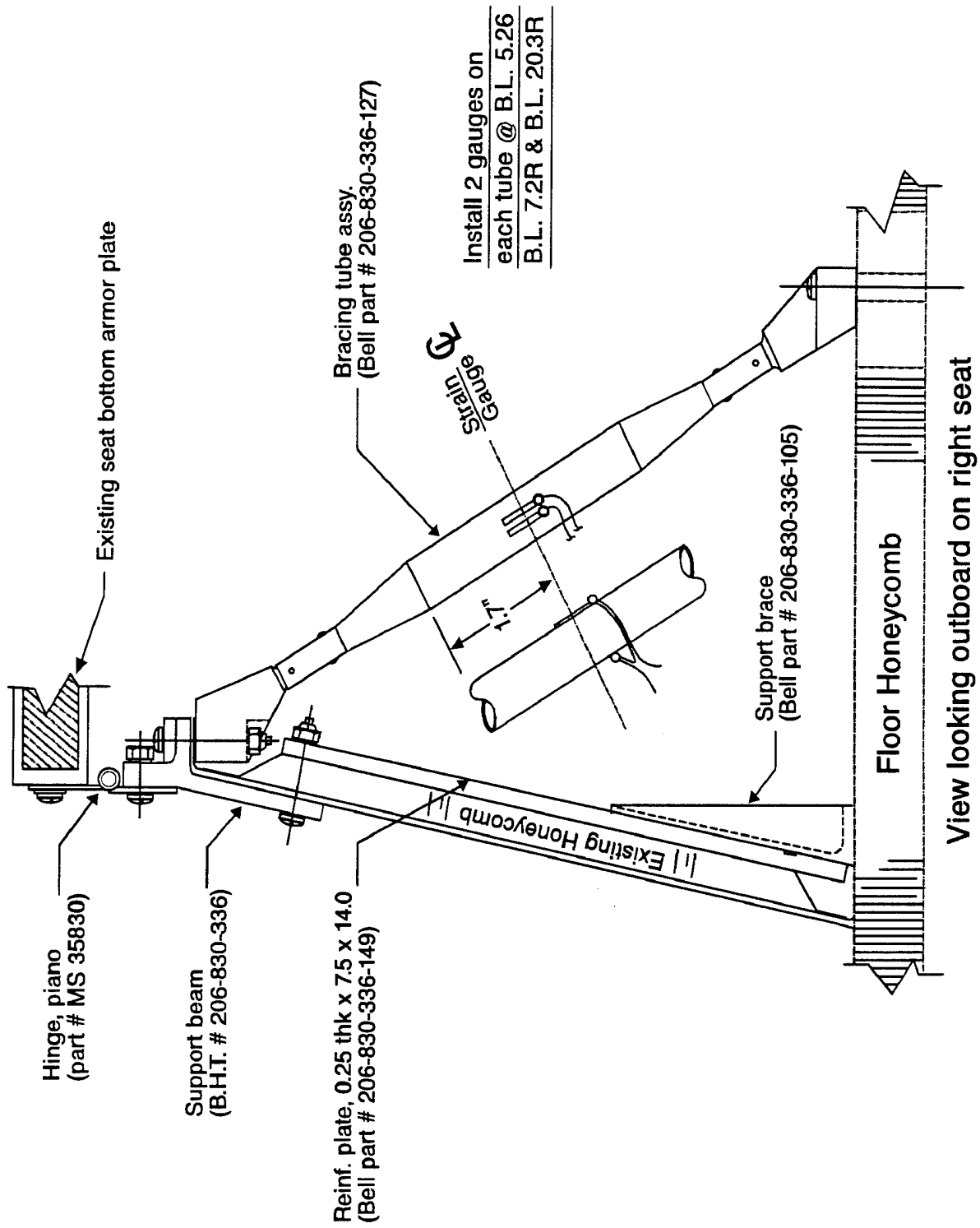

Figure 8b. Hinge line bulkhead for seat pan forward edge support (strain gage installation typical for three tubes).

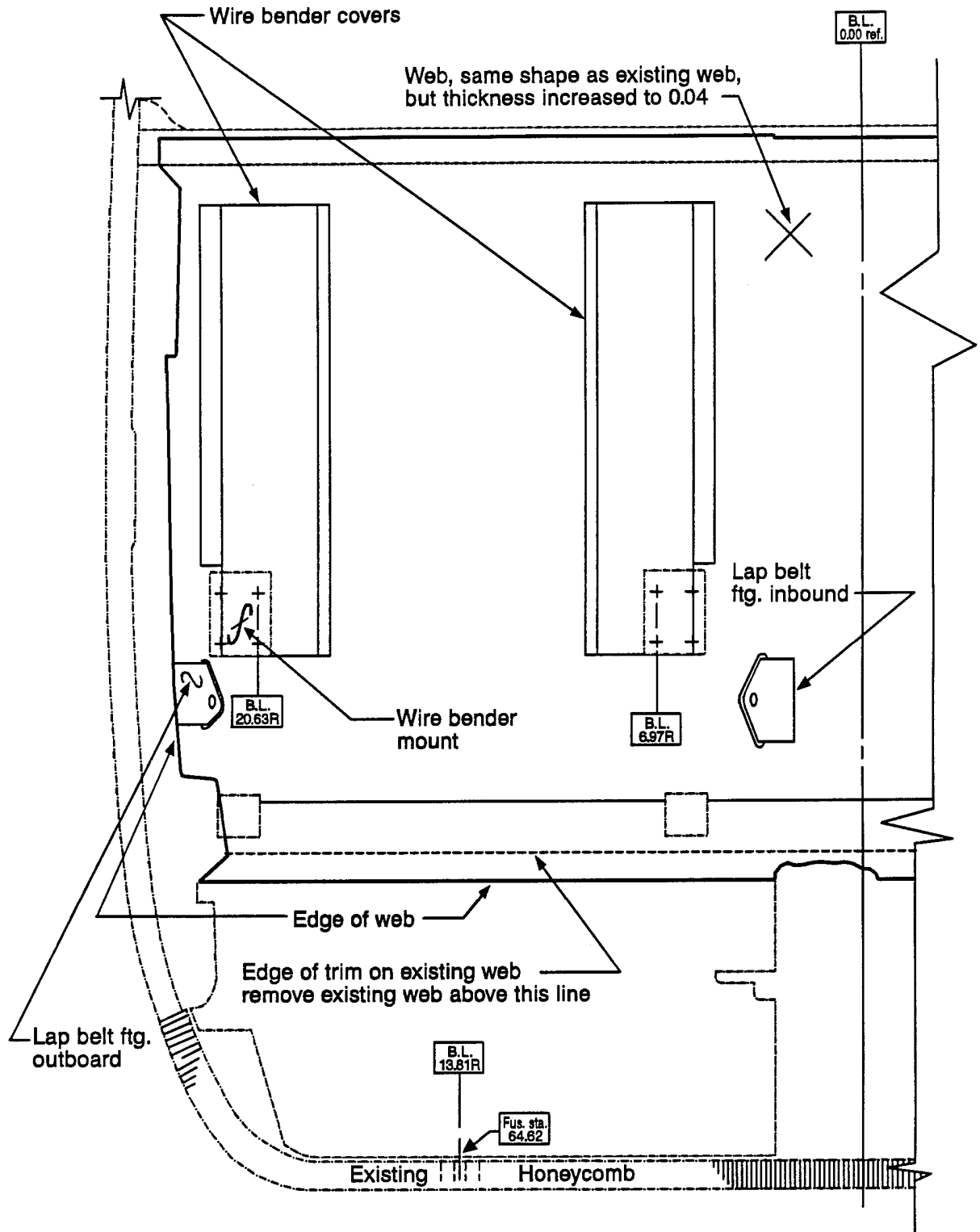

Figure 9. Seat mount bulkhead (view looking aft) (Bell drawing 206-830-335).

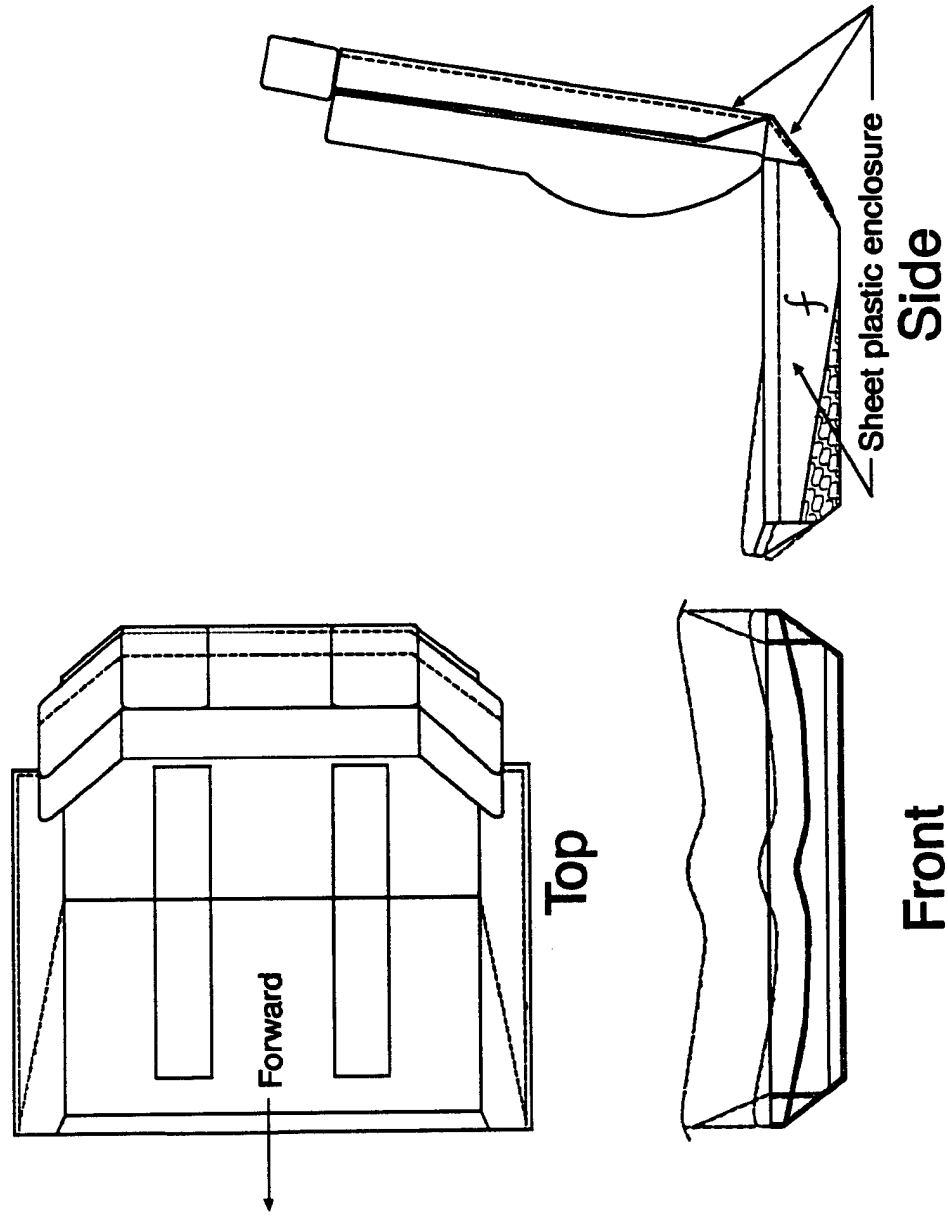

Figure 11. Integrated seat back and seat bottom cushion assembly (note contours at back and bottom).

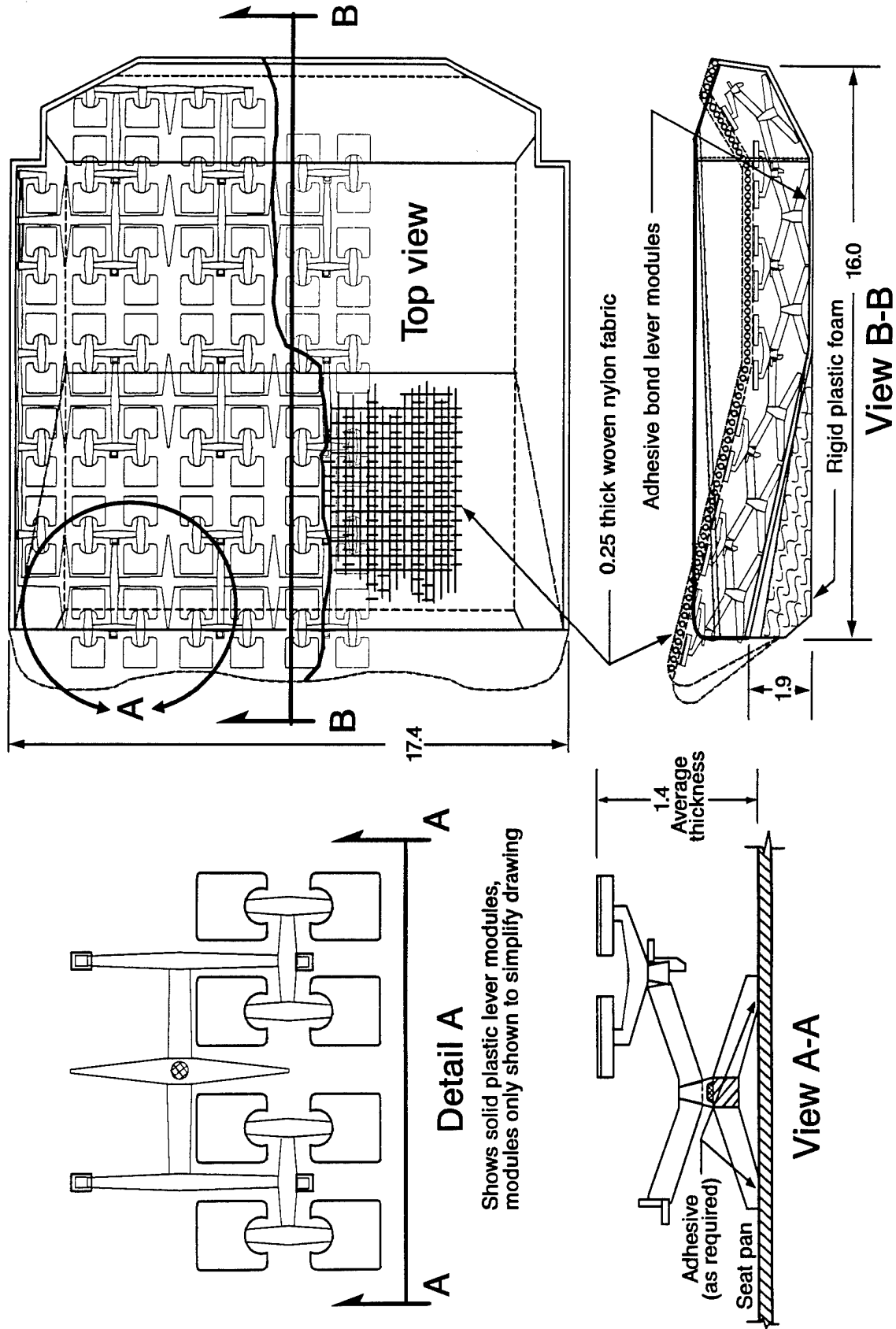

Figure 12. Seat bottom support structure.

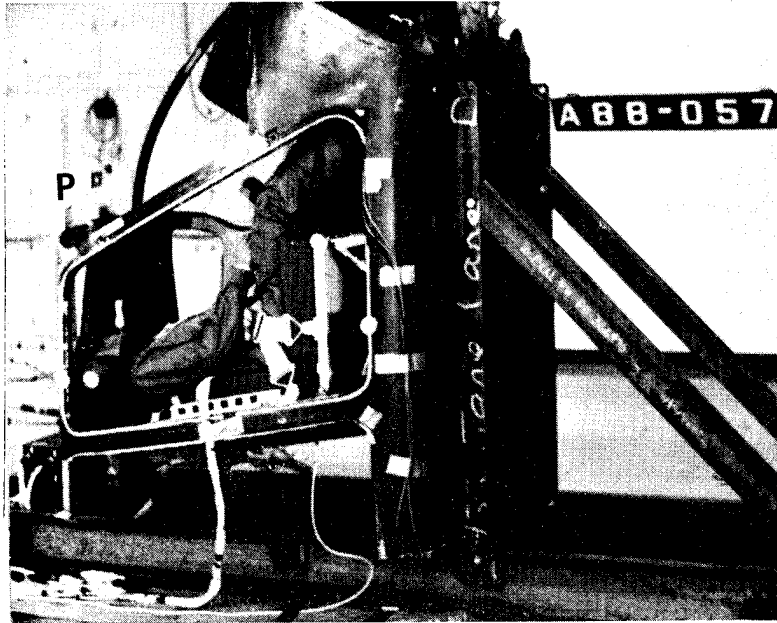

Figure 13. Test setup for pure vertical crash vector--test 88057 (the aluminum channel and bracket used later for pilot display unit tests shown with "P").

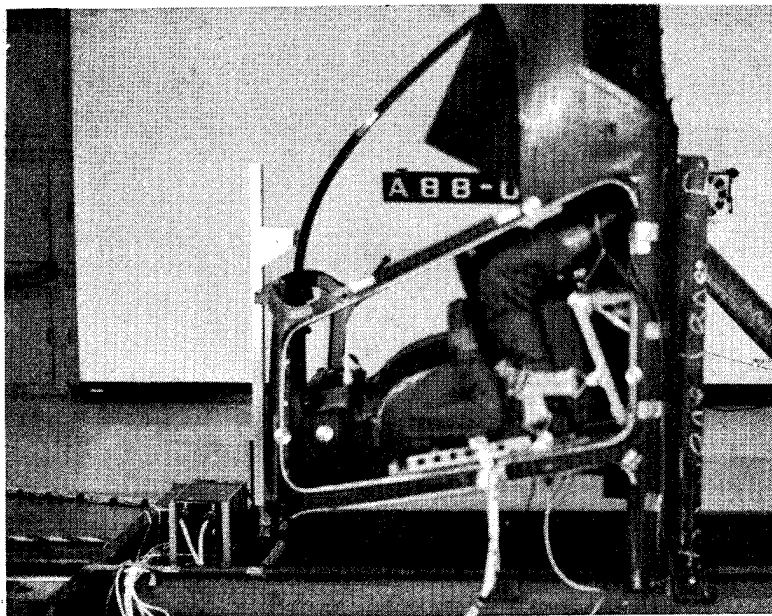

Figure 14. Posttest view of test 88057. (Note the stroked position of the bottom armor plate.)

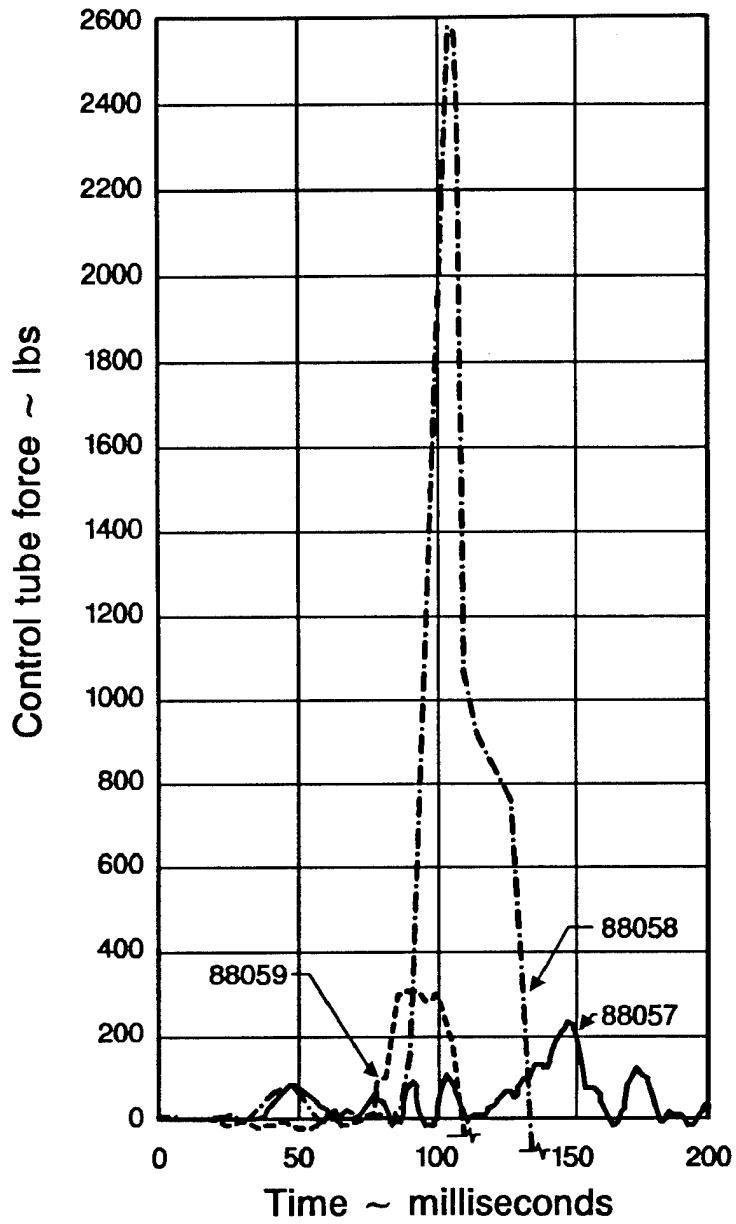
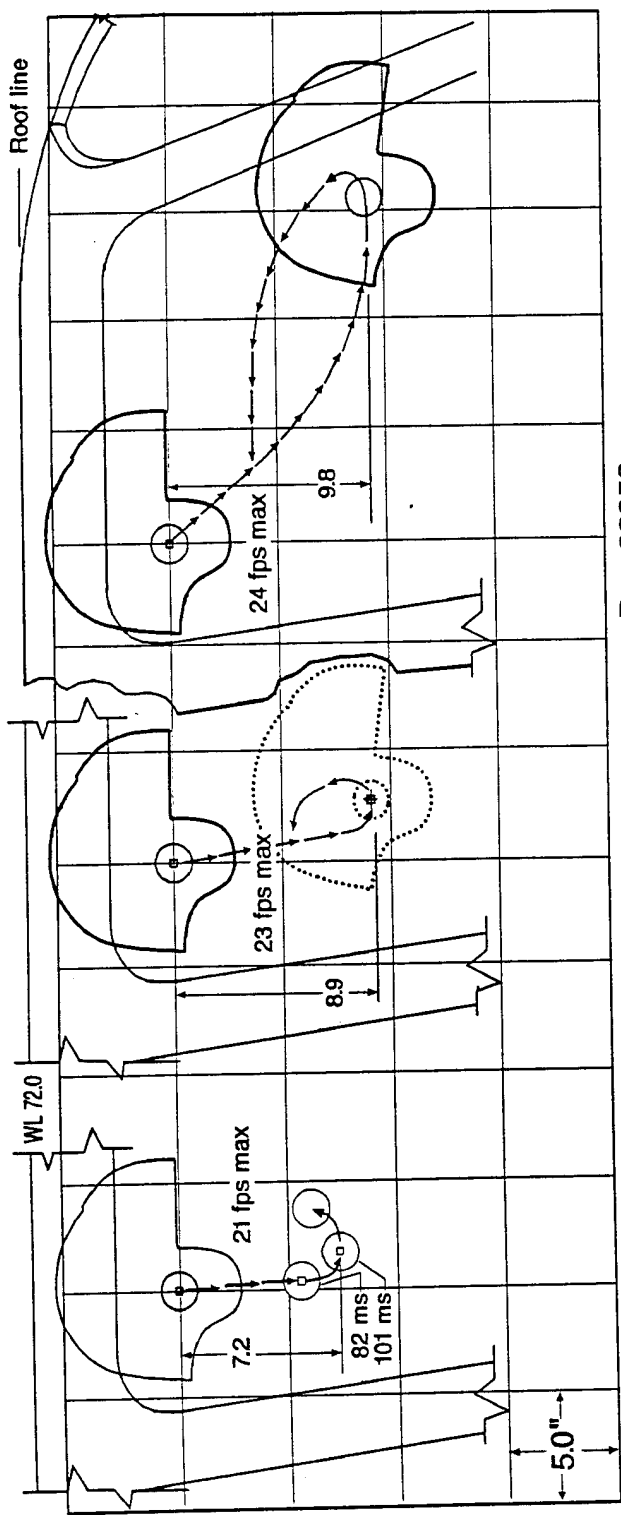
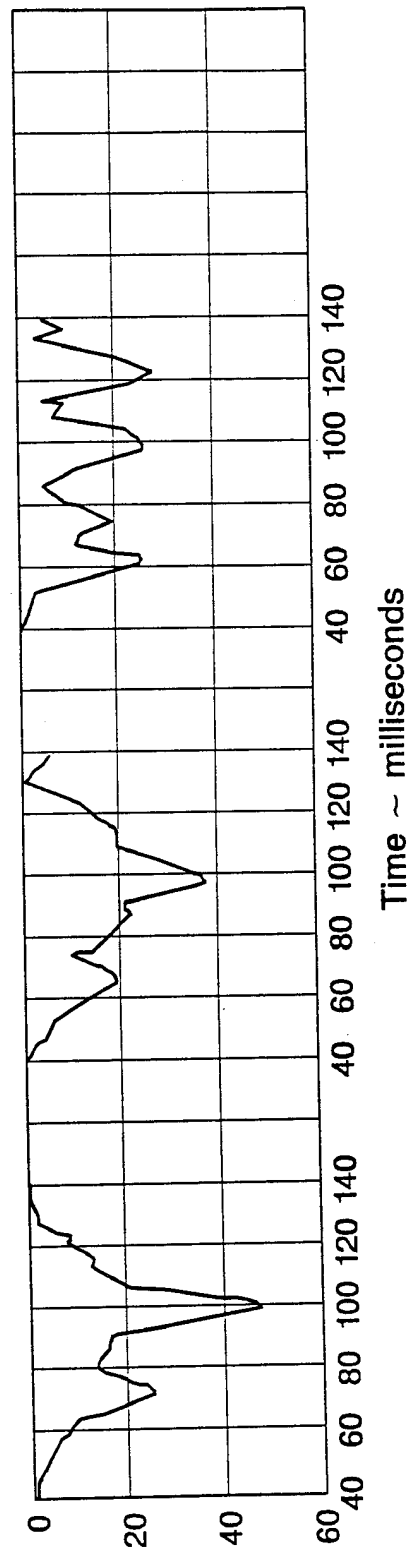

Figure 15. Load cell force measured due to impact of the pivoting seat pan with the under-seat control yoke (see Figures 4 and 23).



Head resultant deceleration - G

Run 88057 Run 88058 Run 88059



Time ~ milliseconds

Figure 16. Measured helmet movement of right side dummy from film analysis and head deceleration (runs 88057, 88058, and 88059).

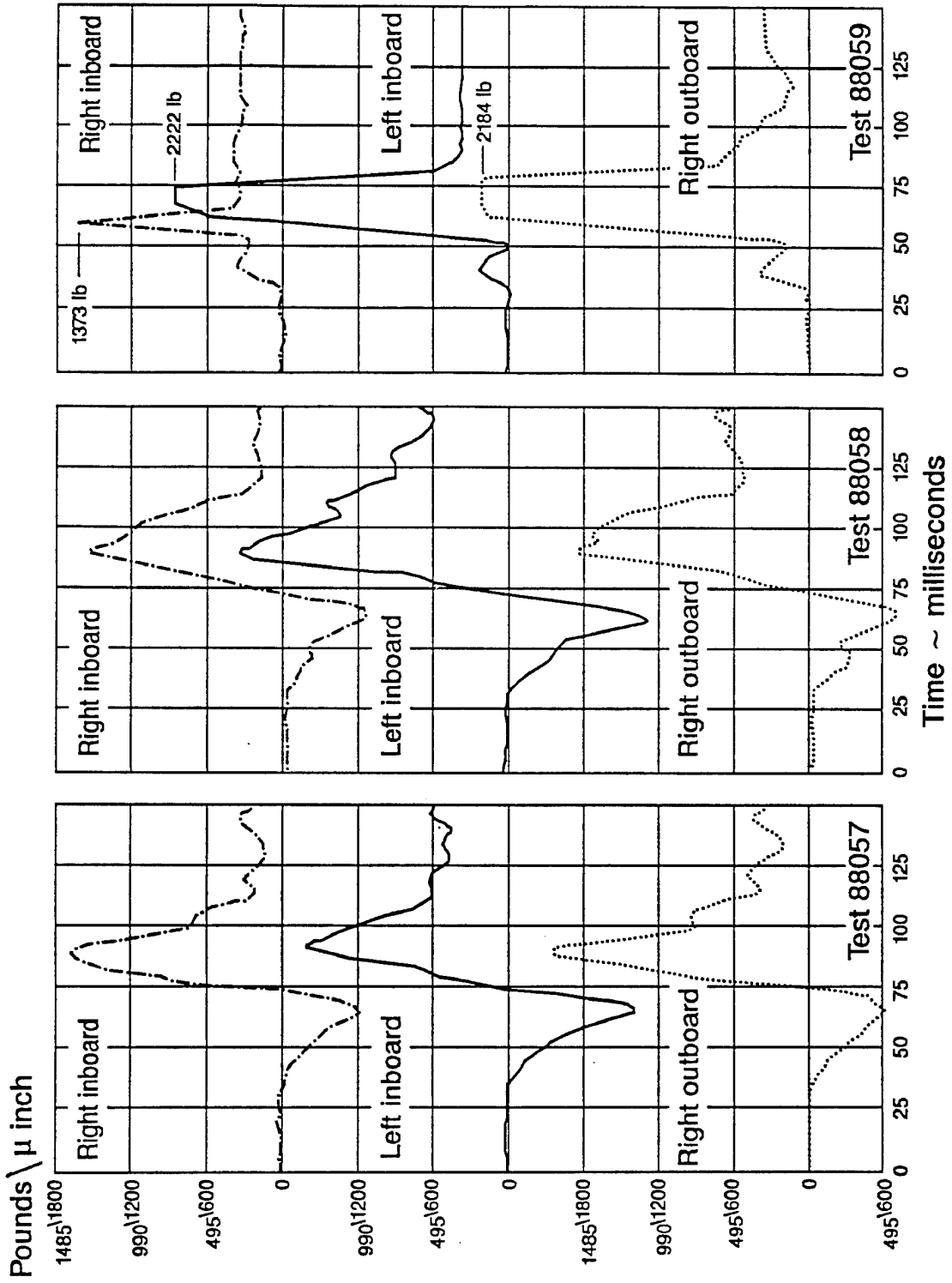

Figure 17. Measured axial strain in aluminum bracing tubes and calculated loads.

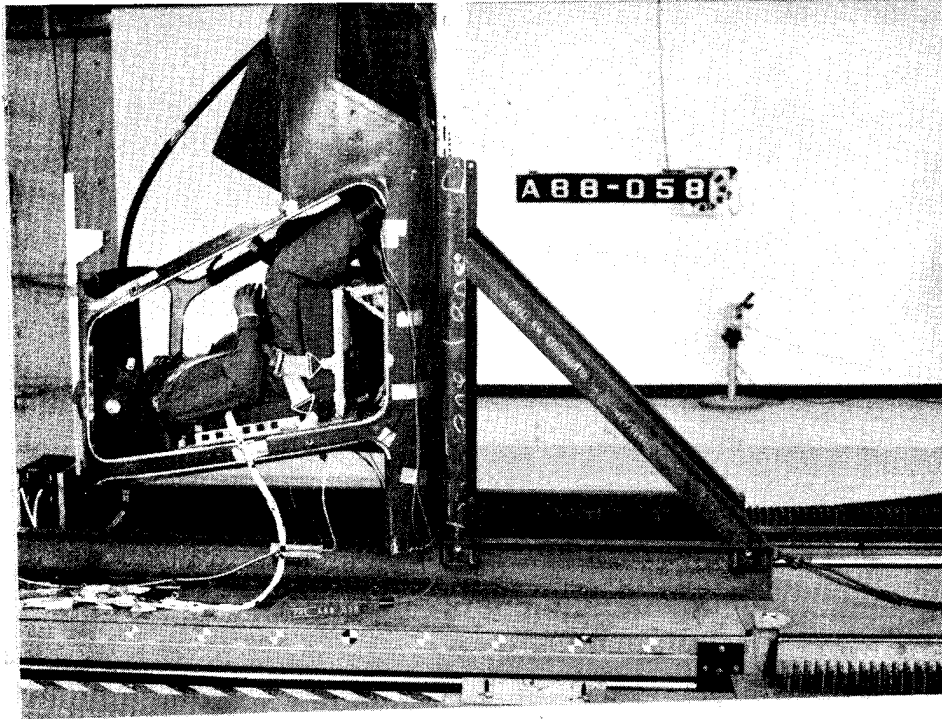

Figure 18. Pretest view of test 88058 (note added beams below nose to stiffen the fuselage).

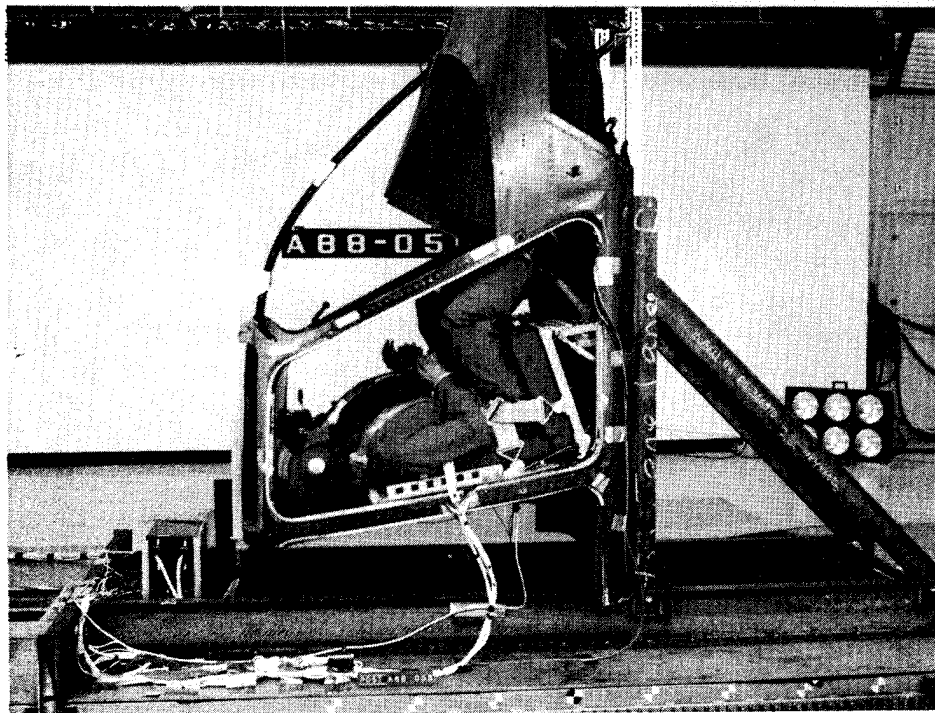

Figure 19. Posttest view of test 88058 (note the stroked position of the bottom armor plate).

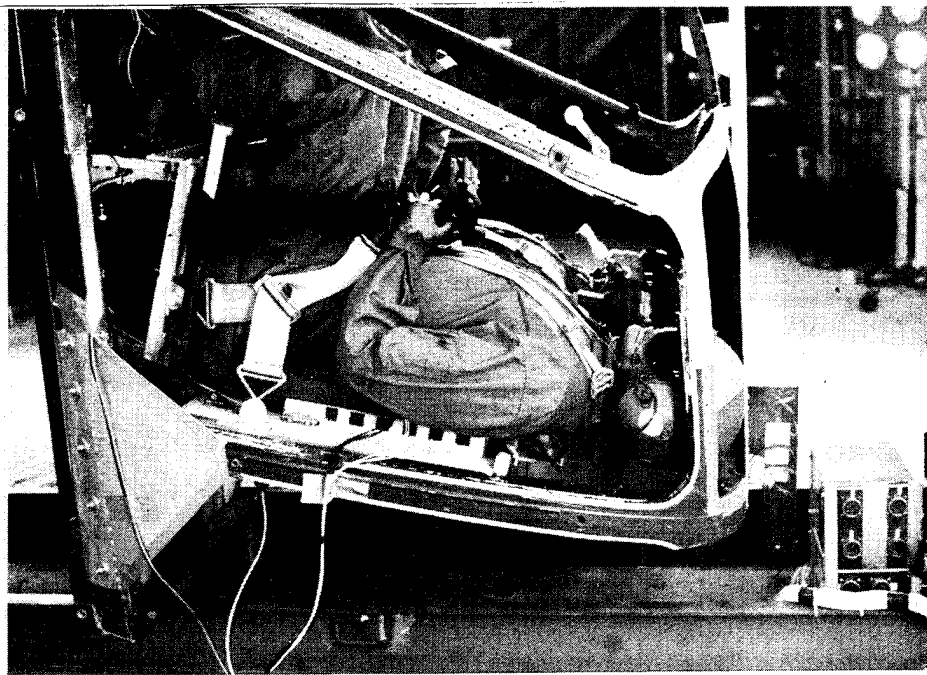

Figure 20. Posttest view of test 88058, showing 95th percentile VIP dummy (note the .05-inch thick aluminum sheet used to stabilize the floor-to-bulkhead joint, and the slack in the wire bender at point "W").

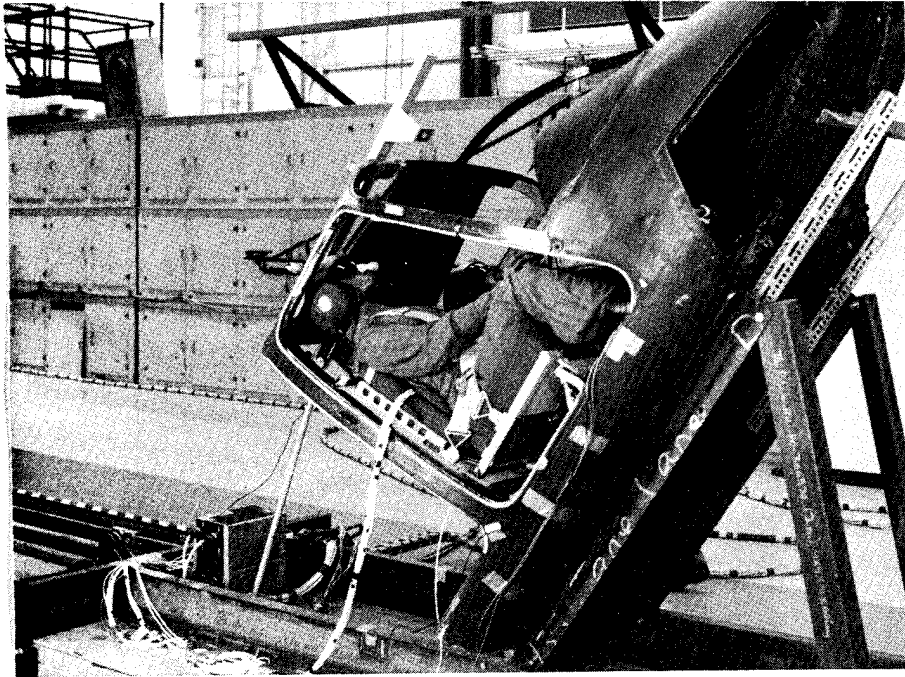

Figure 21. Pretest view of test 88059 (note the fuselage is pitched 56 degrees from vertical in lieu of 90 degrees).

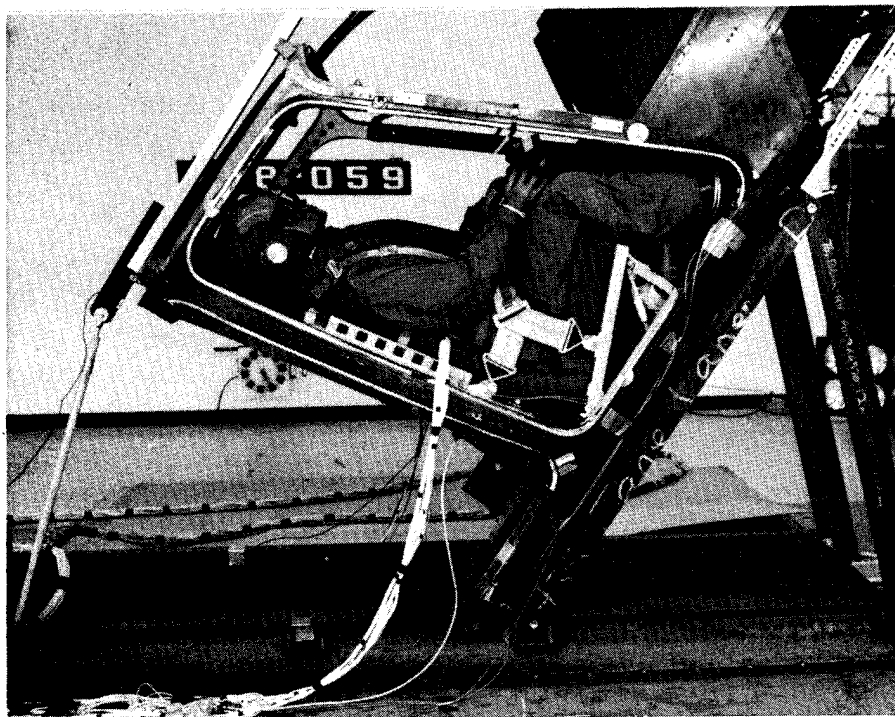

Figure 22. Posttest view of test 88059 (note slack wire bender device).

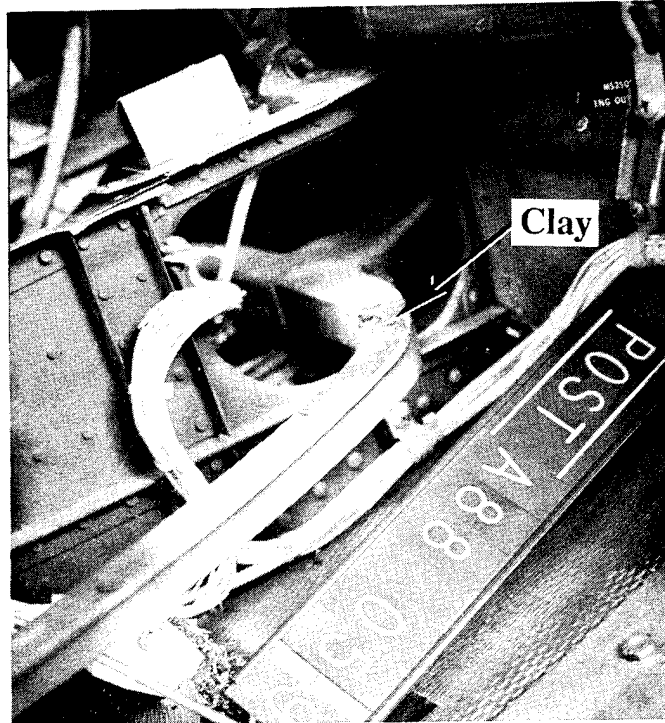

Figure 23. Modeler's clay on underfloor yoke revealing the impact point of the left armor plate (note failure of BL 5.21 brace tube anchorage).

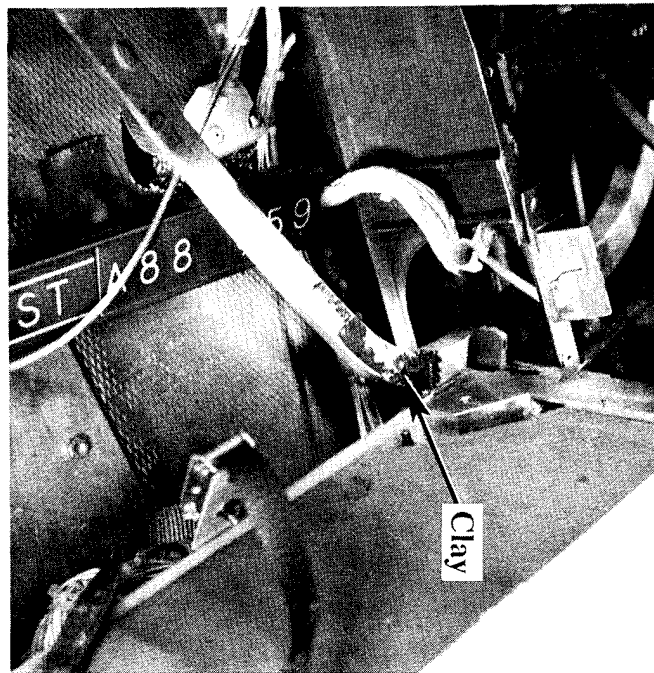

Figure 24. Underfloor yoke impact at bottom armor plate rear edge.



Figure 25. Failure of BL 20.3 right outboard brace tube anchorage to floor.

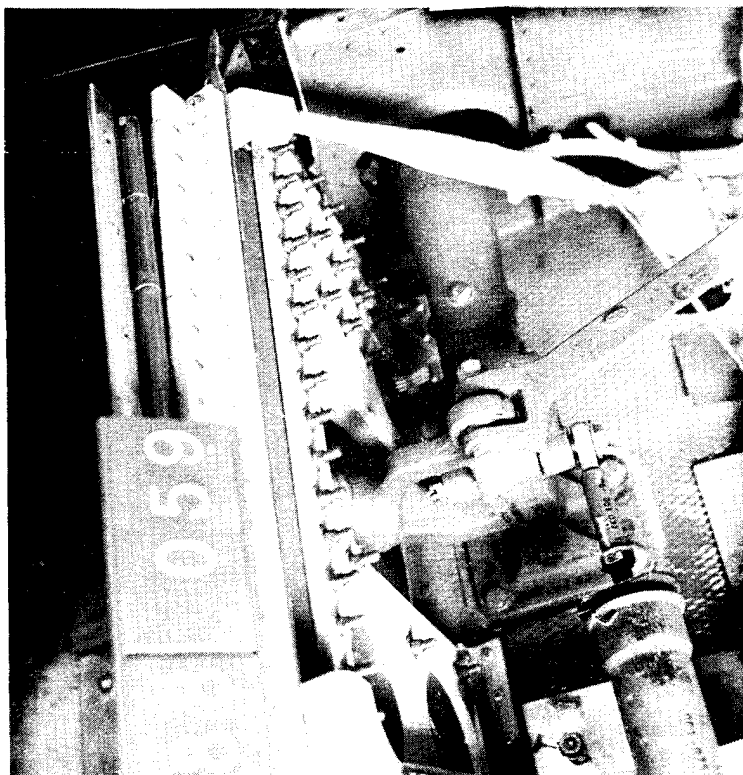

Figure 26. **Posttest view of BL 17.5 left brace and BL 5.2 left brace tube (note slight separation of M535830 hinge at inboard edge).**

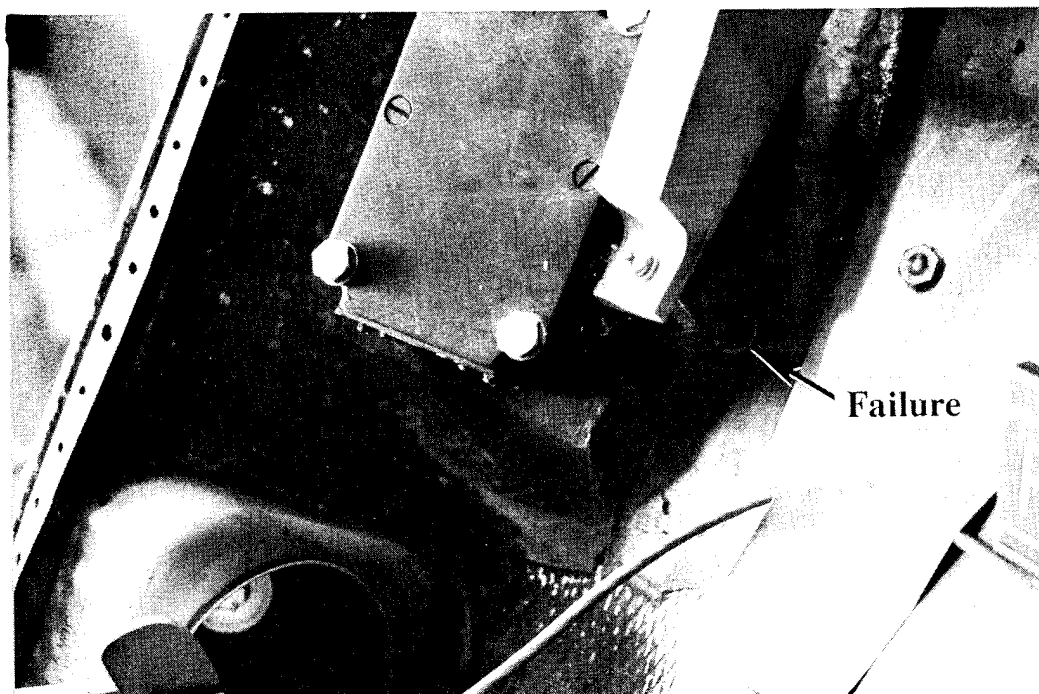

Figure 27. **Failure of BL 17.5 left brace anchorage to floor.**

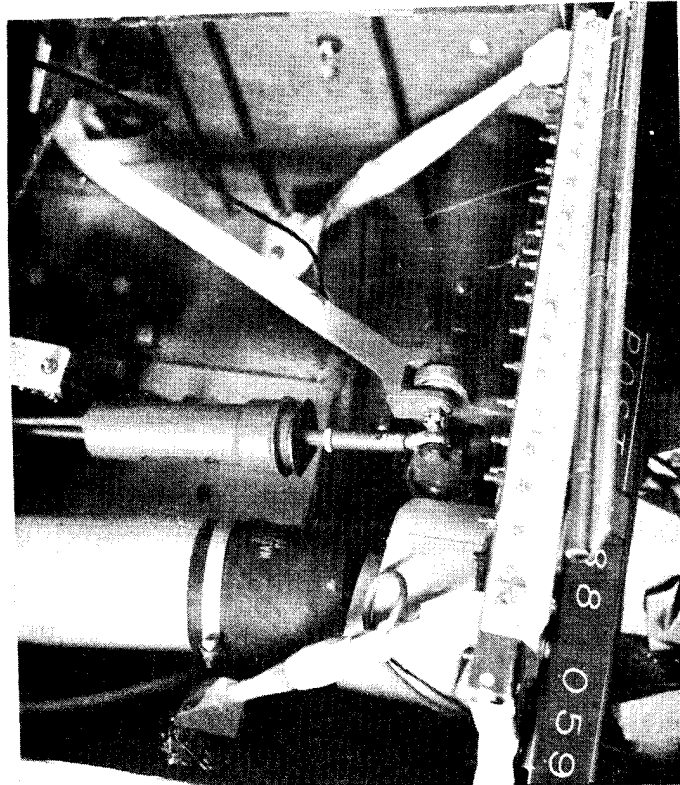

Figure 28. View of right seat area after removal of armor plate at hinge (note separation of M535830 at bottom of photograph).

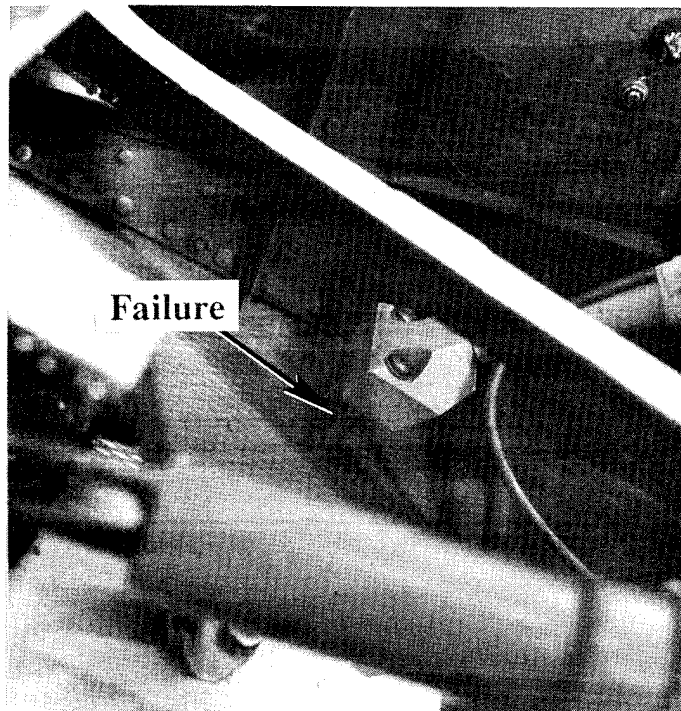

Figure 29. Closeup view of BL 7.2 right anchorage failure at 1373 lb.

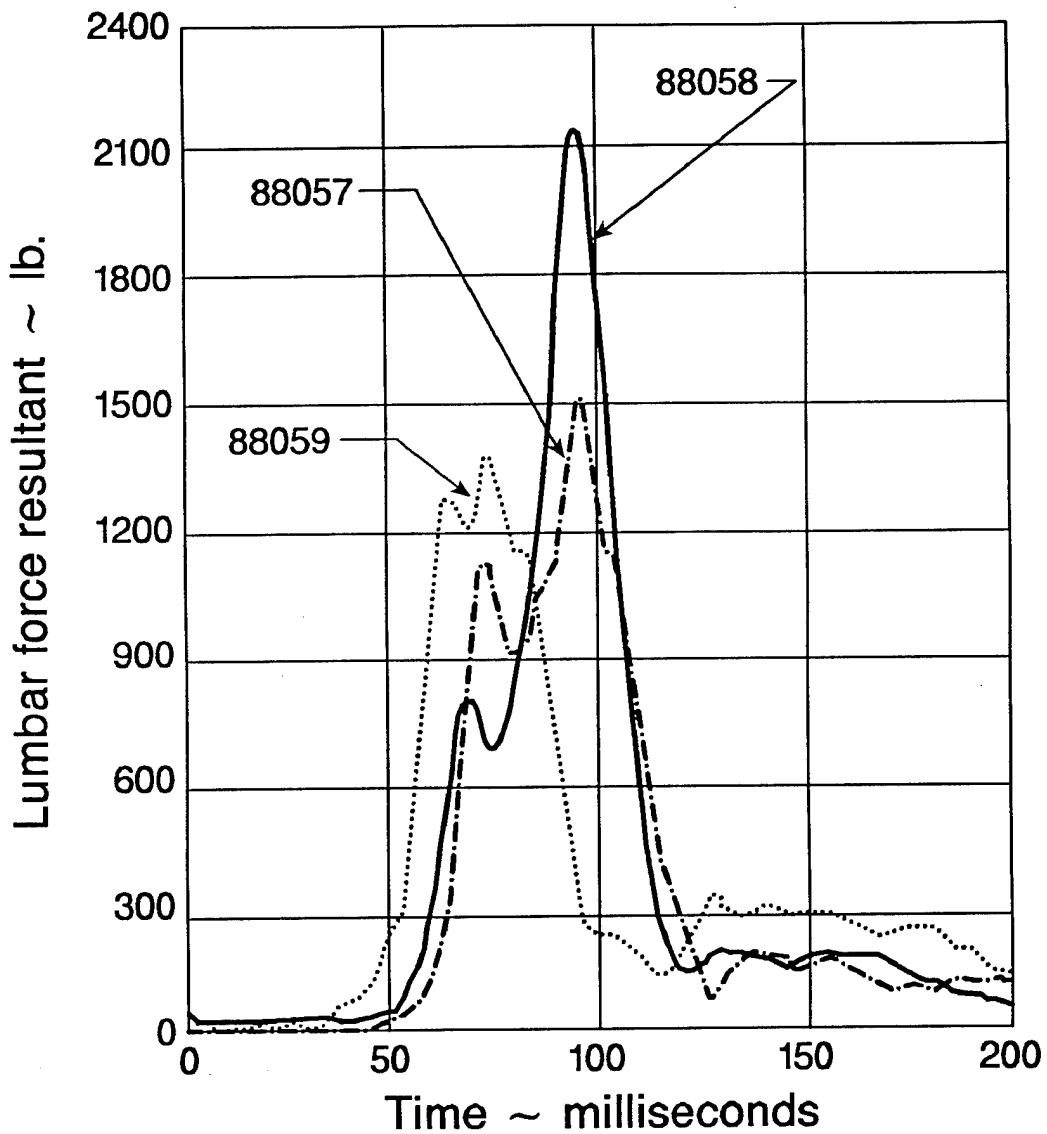

Figure 30. Calculated resultant of X, Y, and Z lumbar load cell vectors in right dummy.

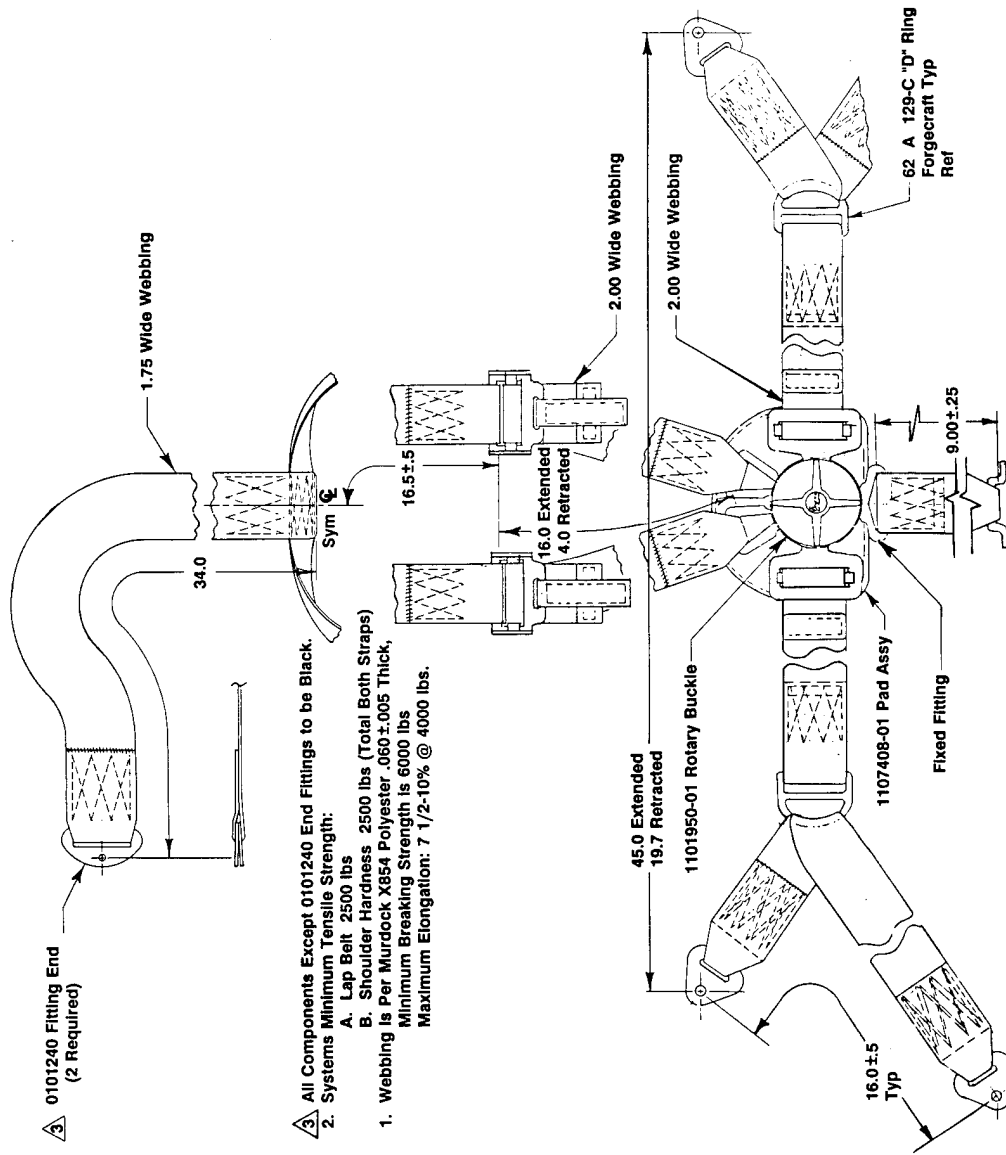

Figure 31. Five-point restraint harness proposal (Pacific Scientific Company, or equivalent).



Figure 32. View of small female pilot in serial 71-20778 with five-point harness and seat pan BRP at 0.97 inch below sled test value (note collective in lowest position).



Figure 33. View of seat back and bottom assembly in serial 70-20778.

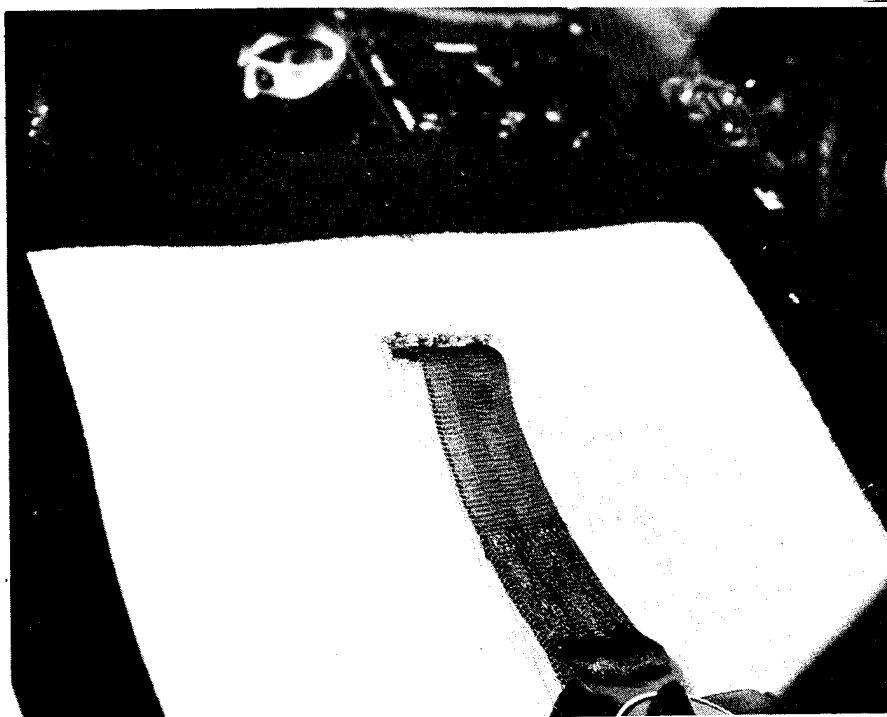

Figure 34. View of tiedown strap exiting hole in seat bottom cushion.

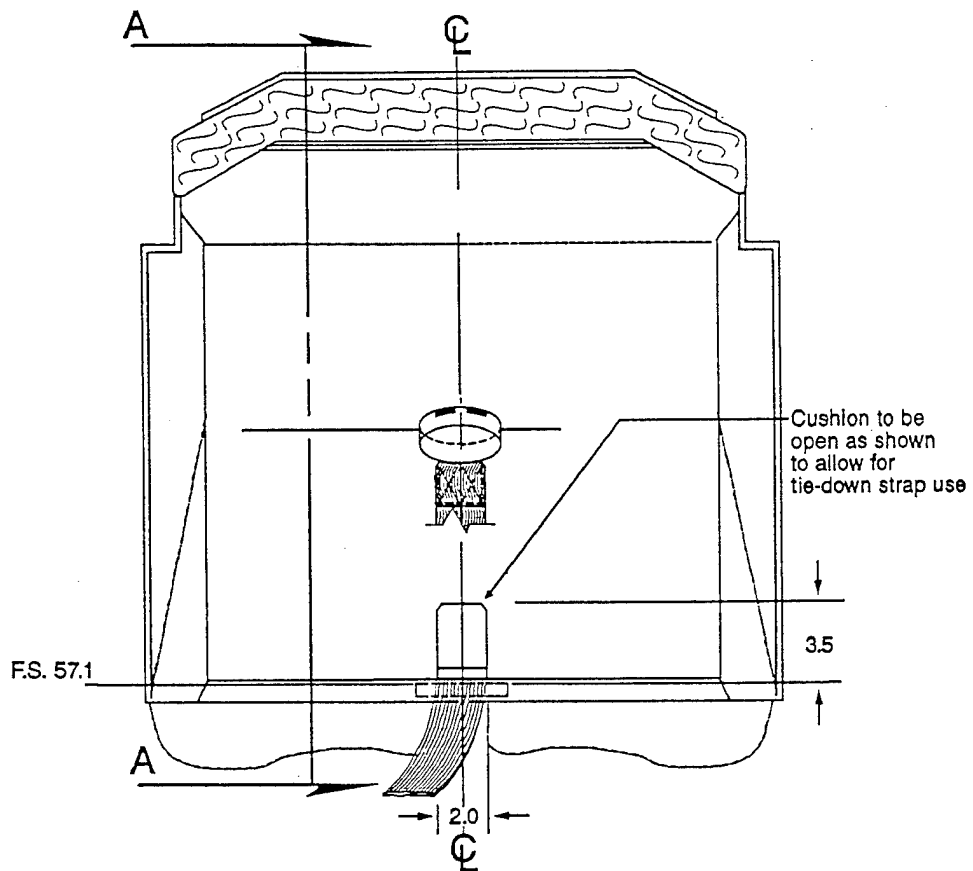
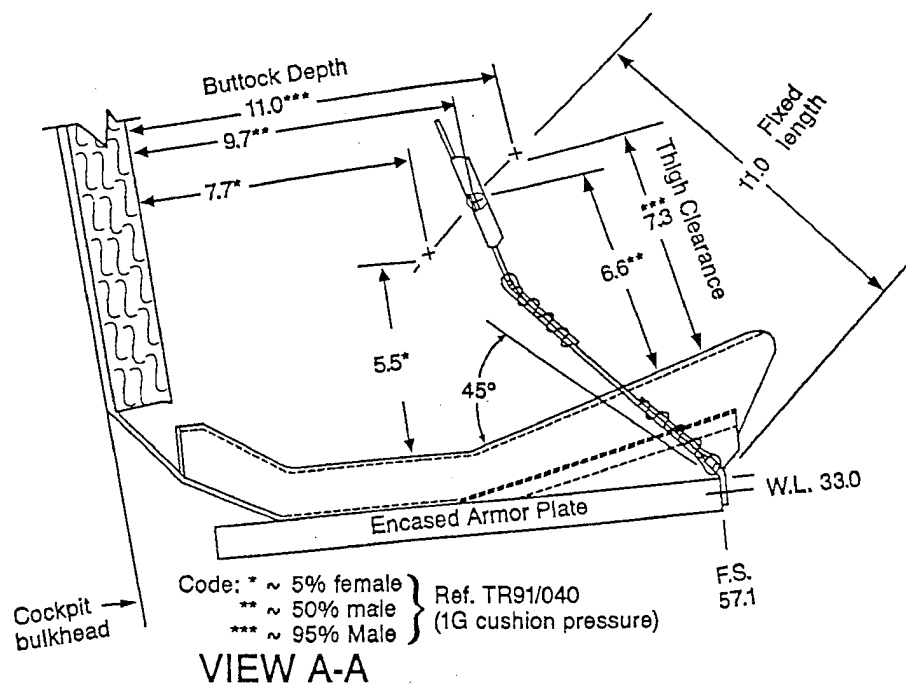

Figure 35. Location of tiedown strap for five-point harness (the 11.0-inch length shown agrees with the 9.0 inch webbing length shown in Figure 31).

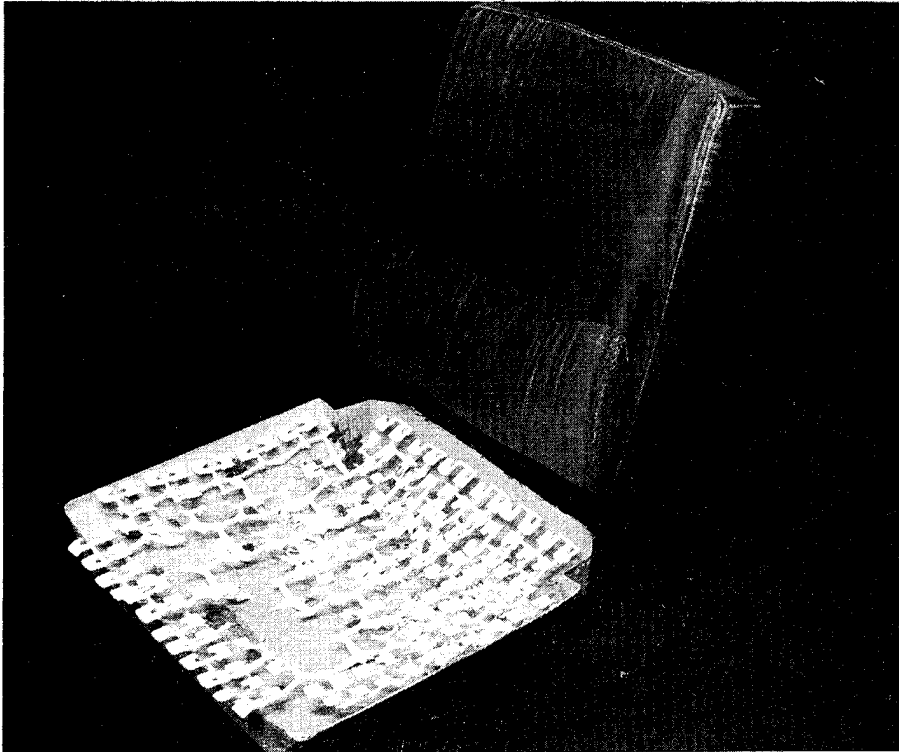

Figure 36a. Copilot seat bottom and back cushions after removal of PREQUAL™ cover after 20 months and 100 flight hours in JOH-58A (Ser 71-20778).

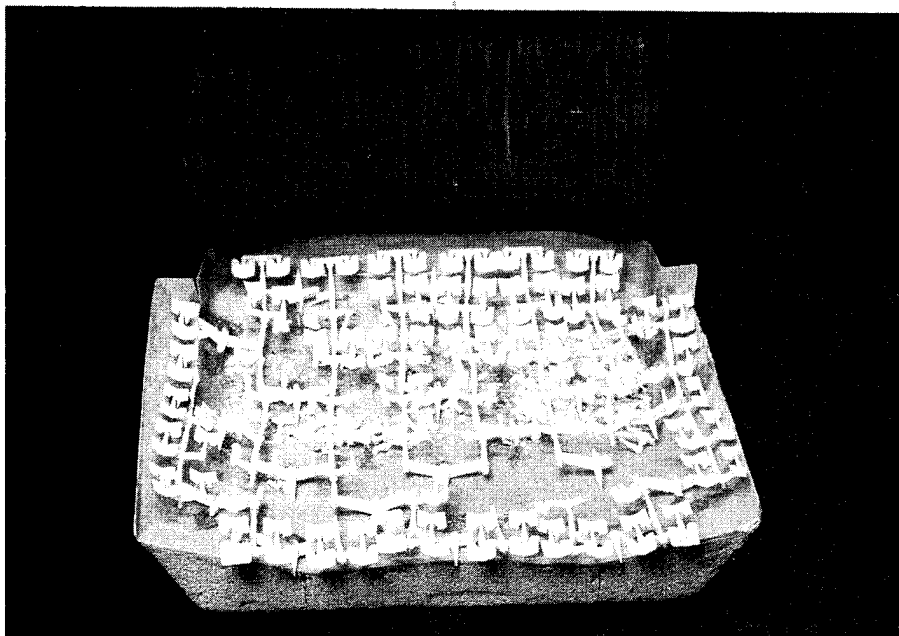

Figure 36b. Copilot (left) seat bottom and back cushions (note disintegrated plastic lever supports).

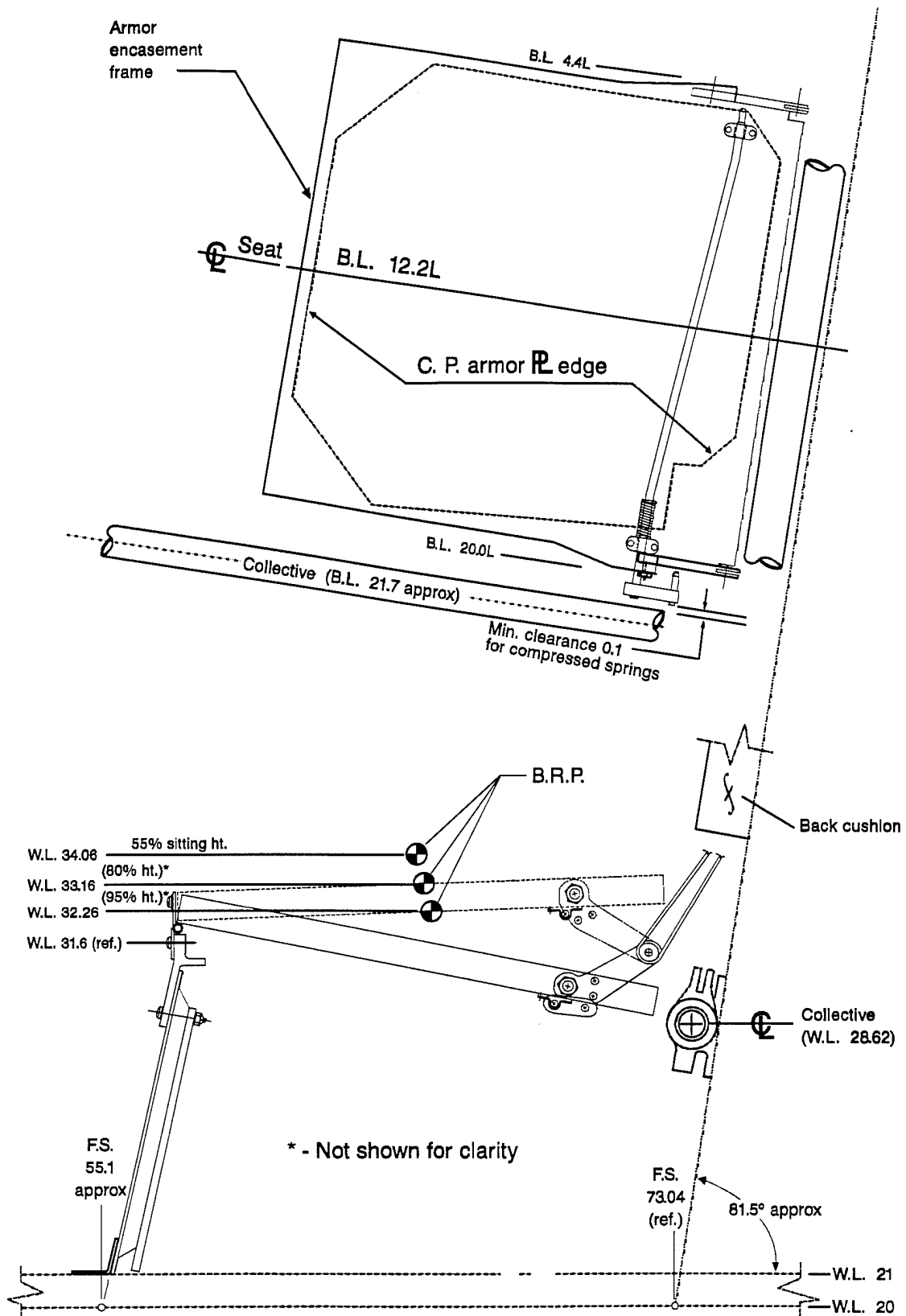
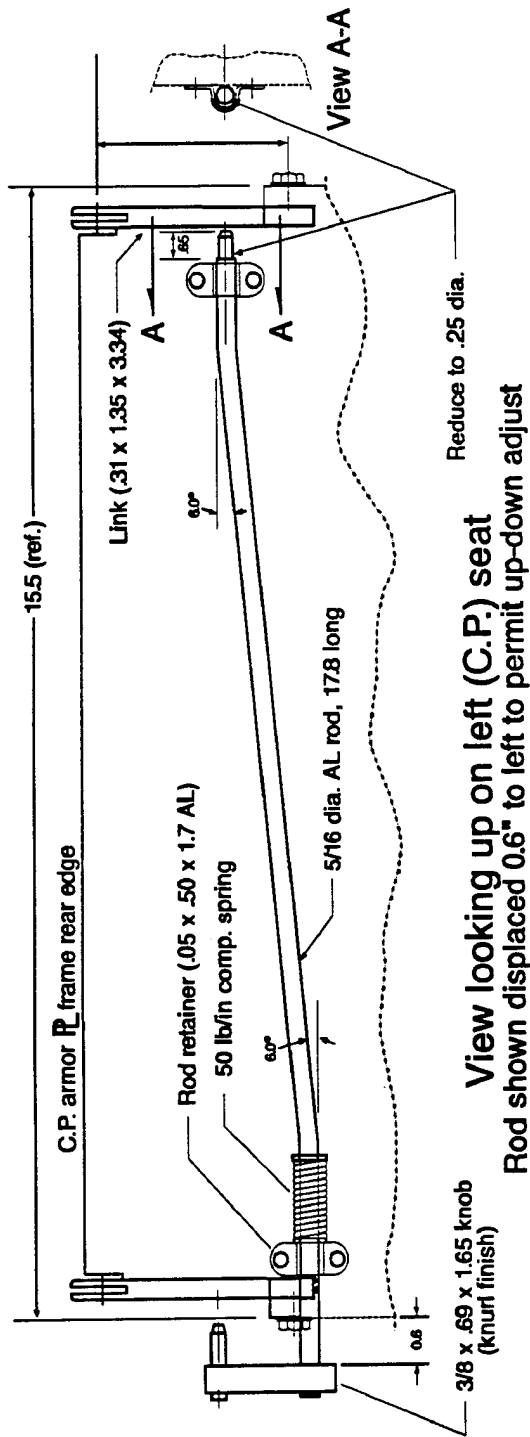
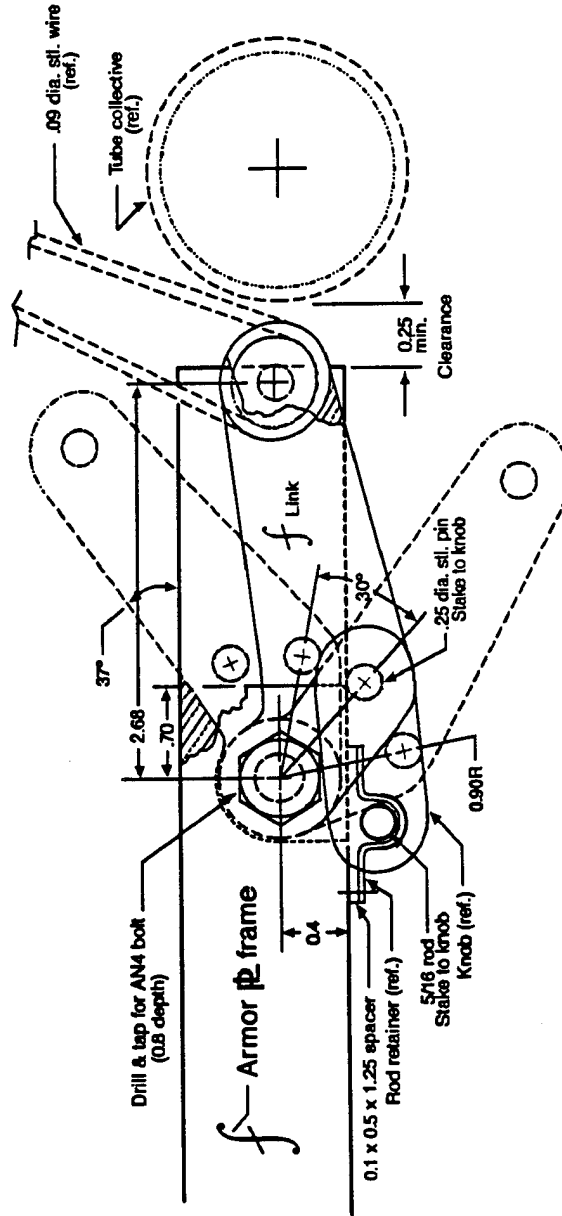

Figure 37a. Vertical seat adjustment concept to provide 1.8-inch BRP movement.



View looking up on left (C.P.) seat
 Rod shown displaced 0.6" to left to permit up-down adjust



View looking inboard on C.P. seat

Figure 37b. Seat adjustment concept details.

Appendix A.

Crashworthy seat transducer results.

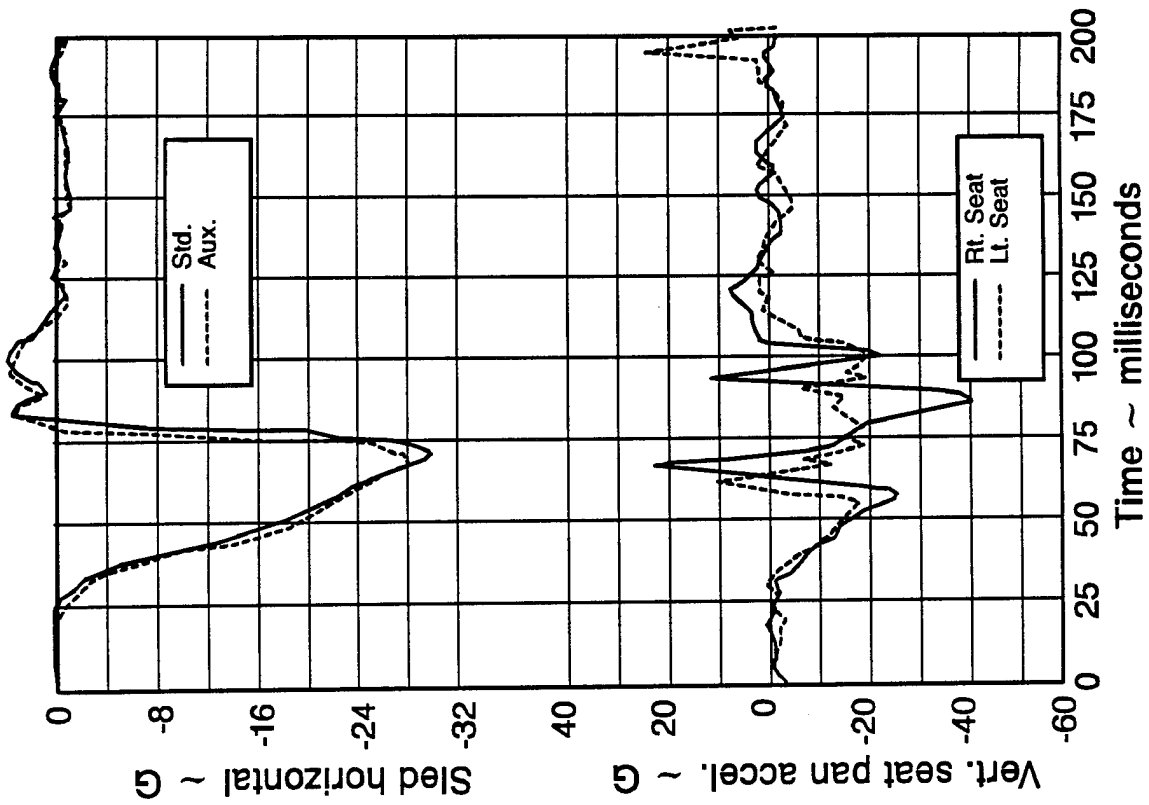
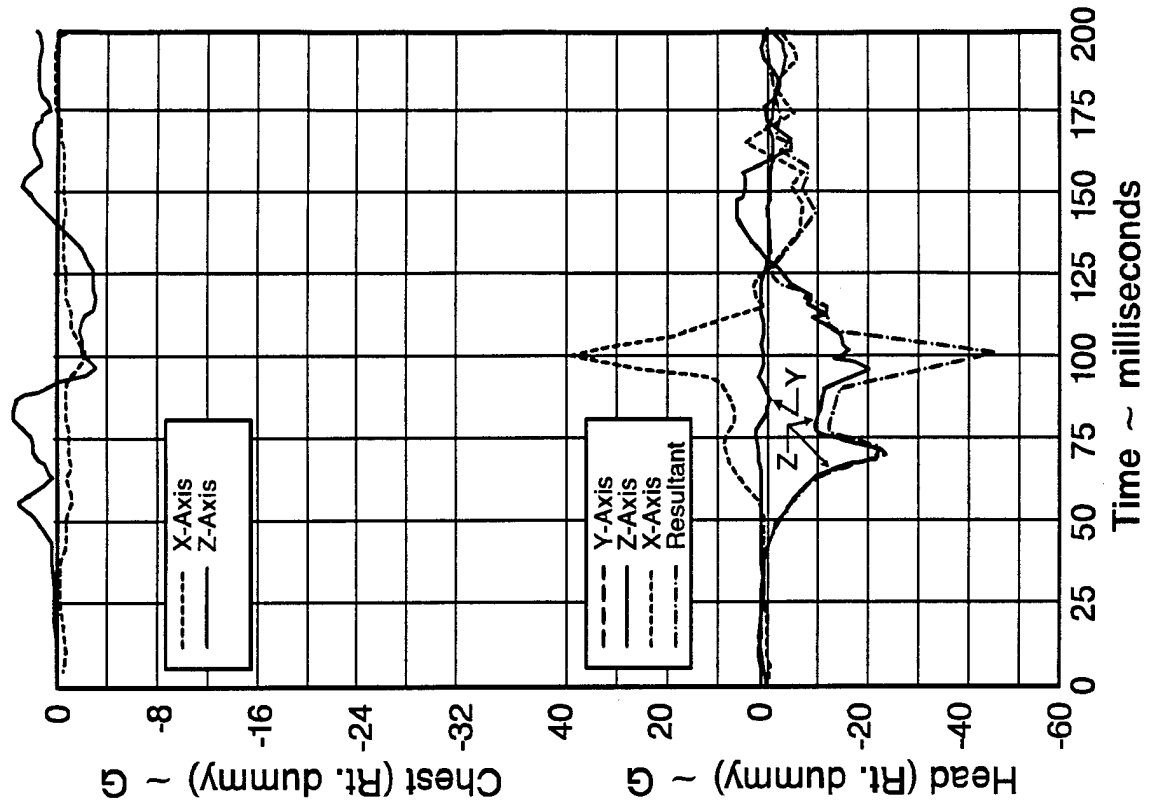

Figure A-1. Sled, seat, and dummy acceleration traces from test 88057.

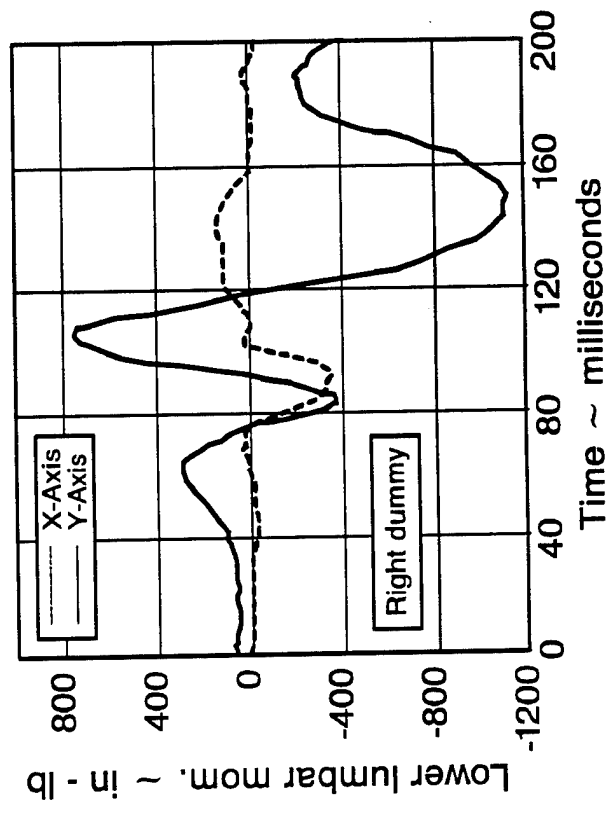
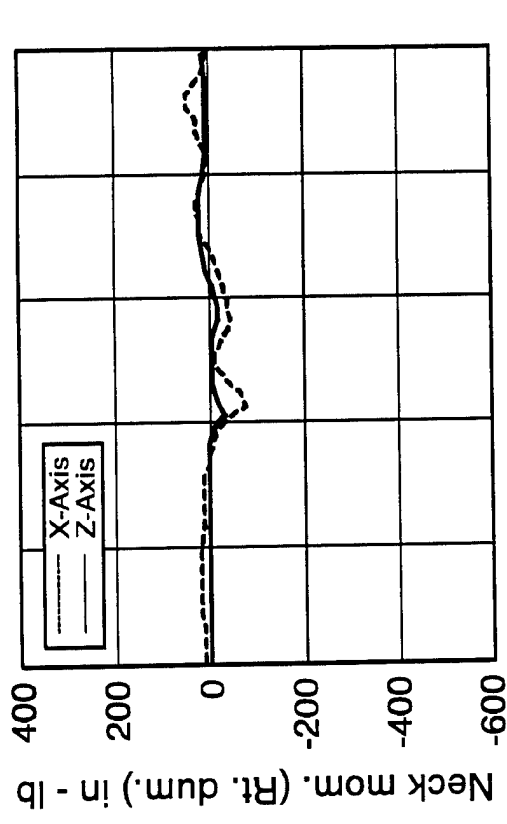
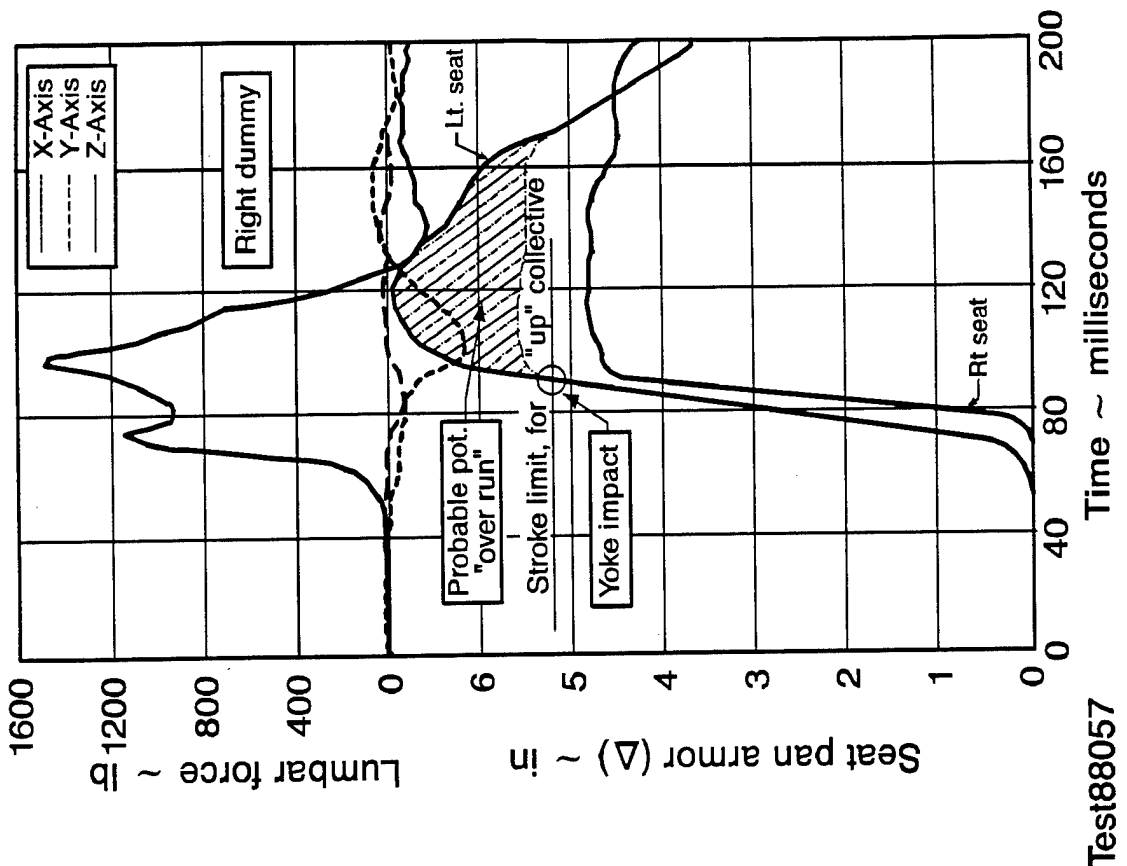

Figure A-2. Seat pan deflection and right dummy neck and lumbar force/moment from test 88057.

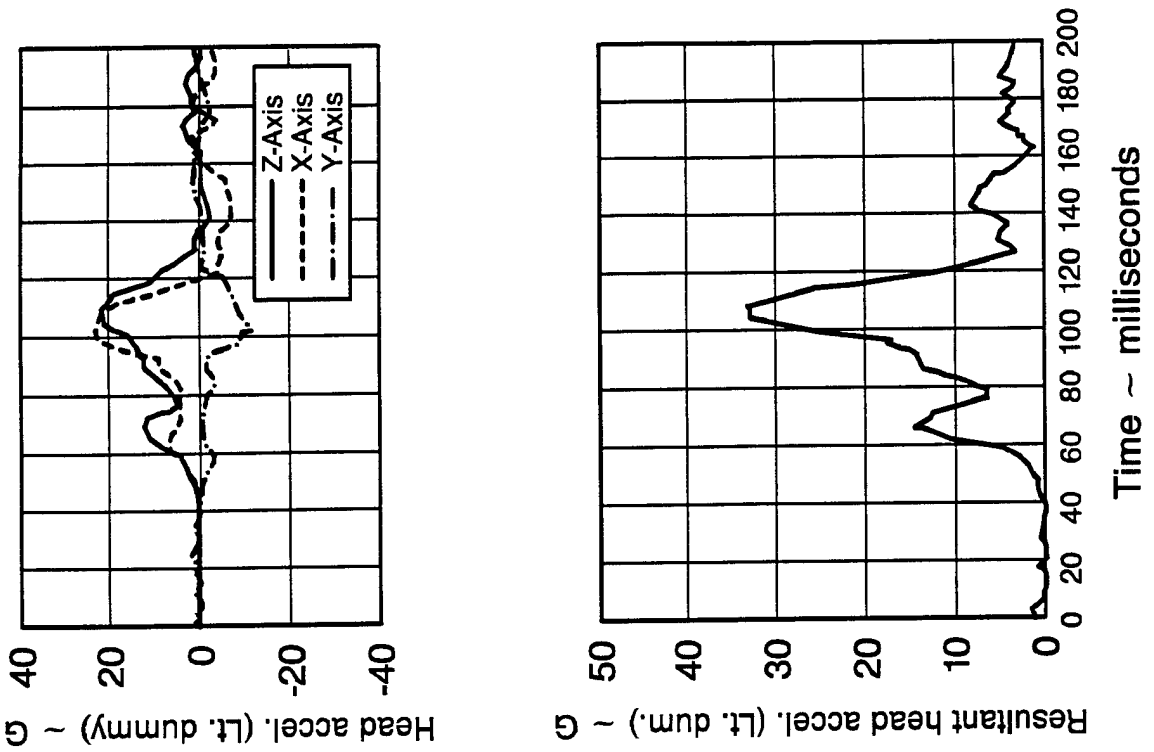

Figure A-3. Head and pelvis accelerations of left dummy in test 88057.

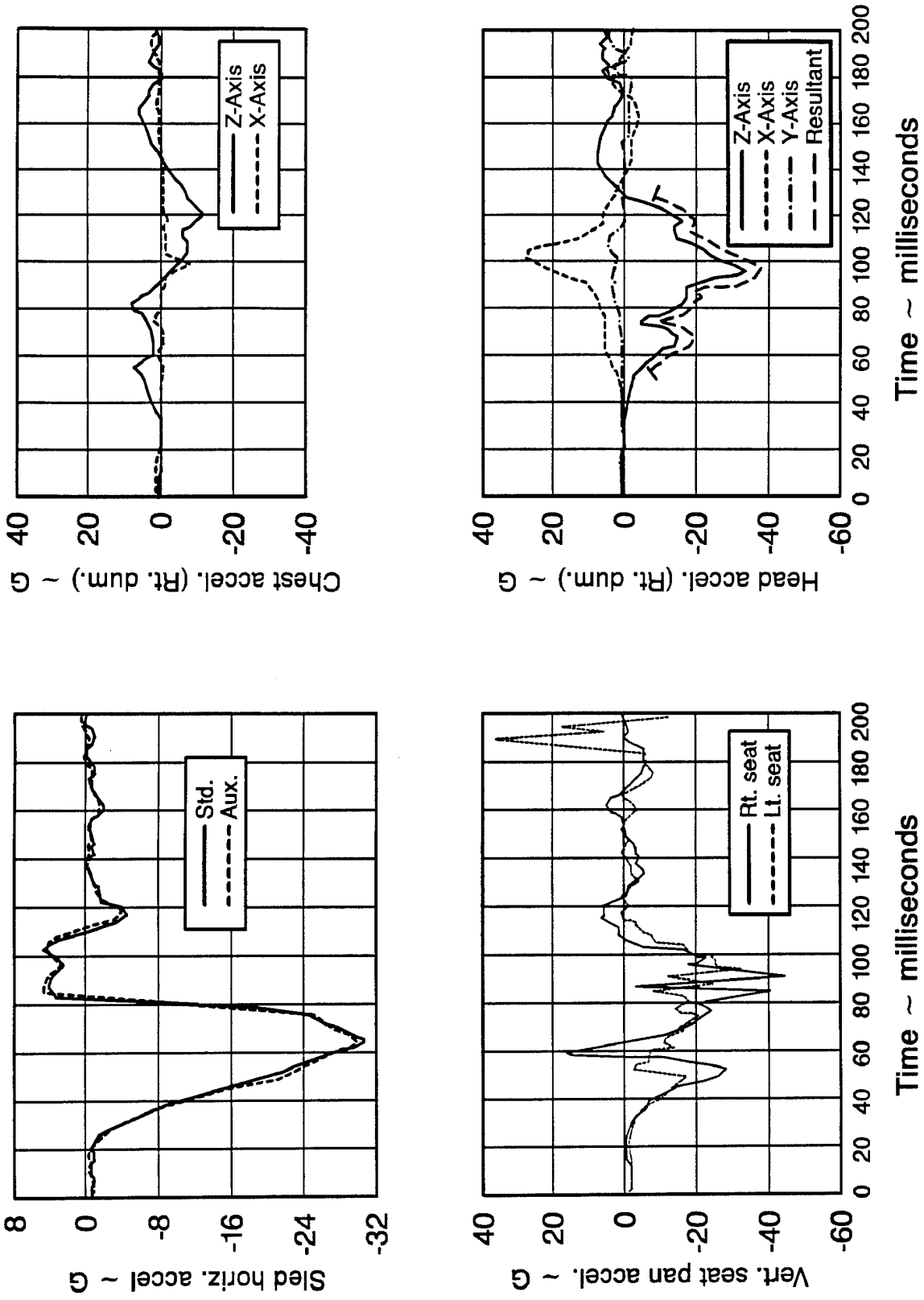

Figure A-4. Sled, seat, and dummy acceleration traces from test 88058.

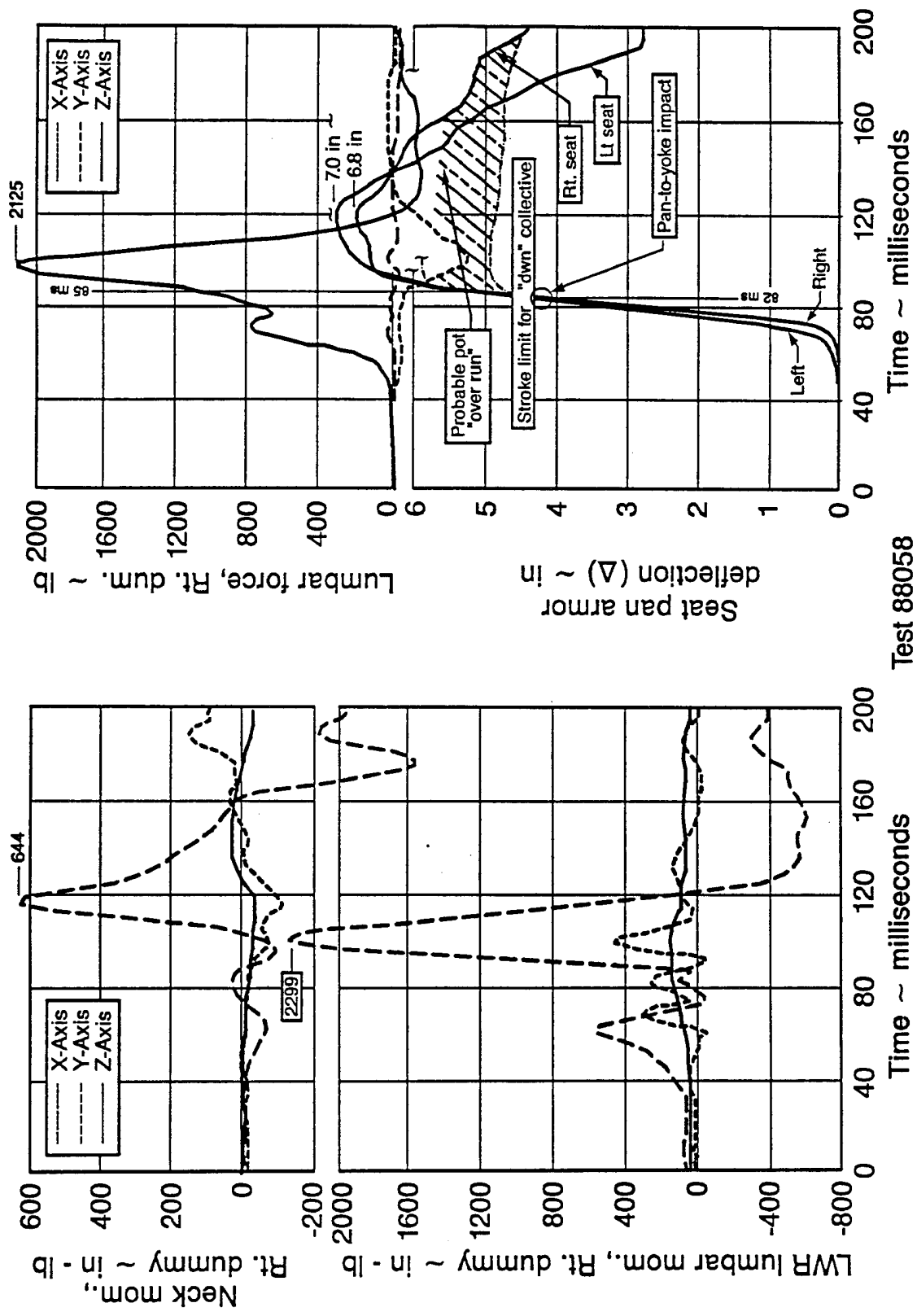
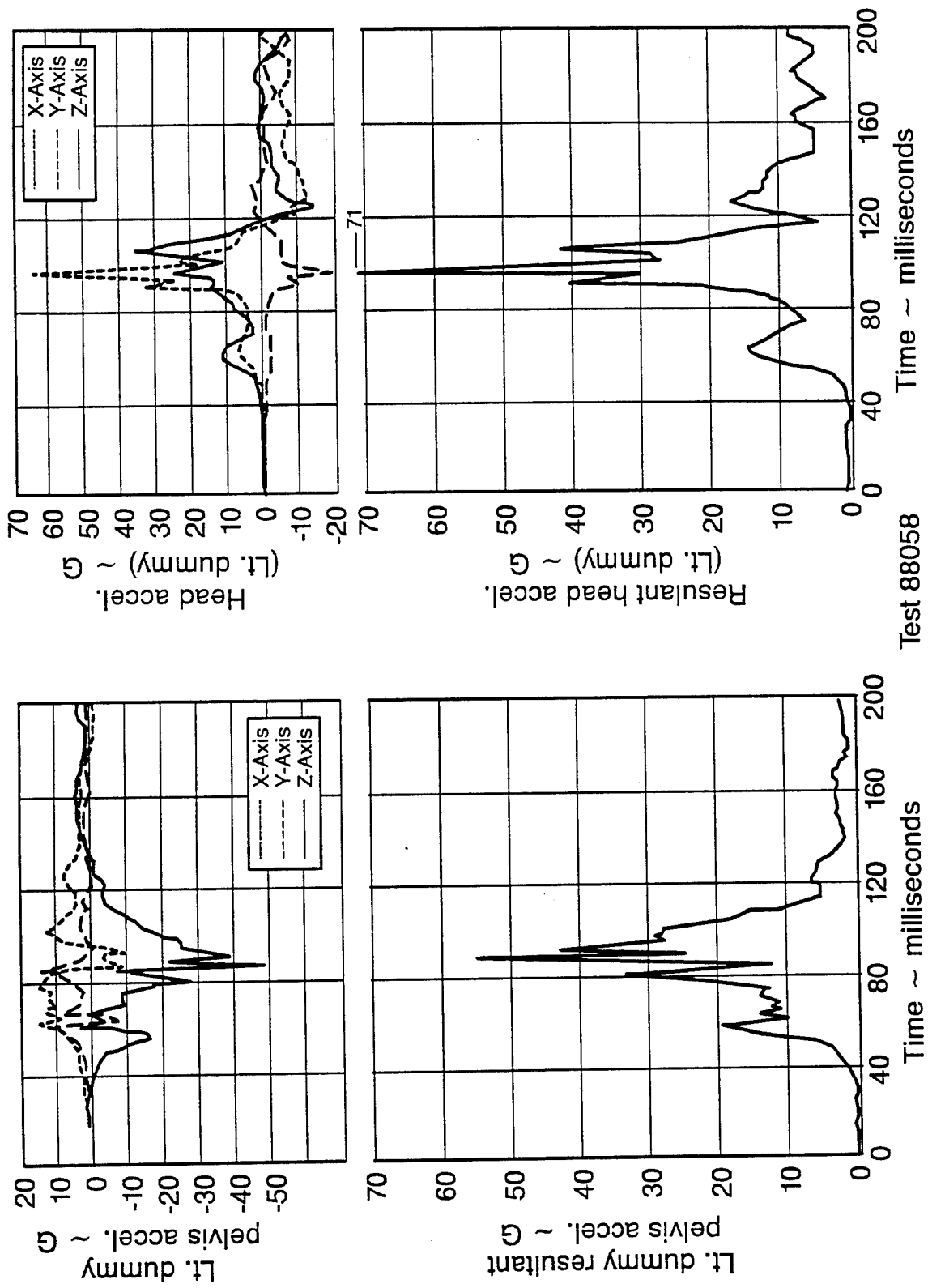

Figure A-5. Seat pan deflection and right dummy neck and lumbar force/moment from test 88058.



Test 88058

Figure A-6. Head and pelvis accelerations of left dummy in test 88058.

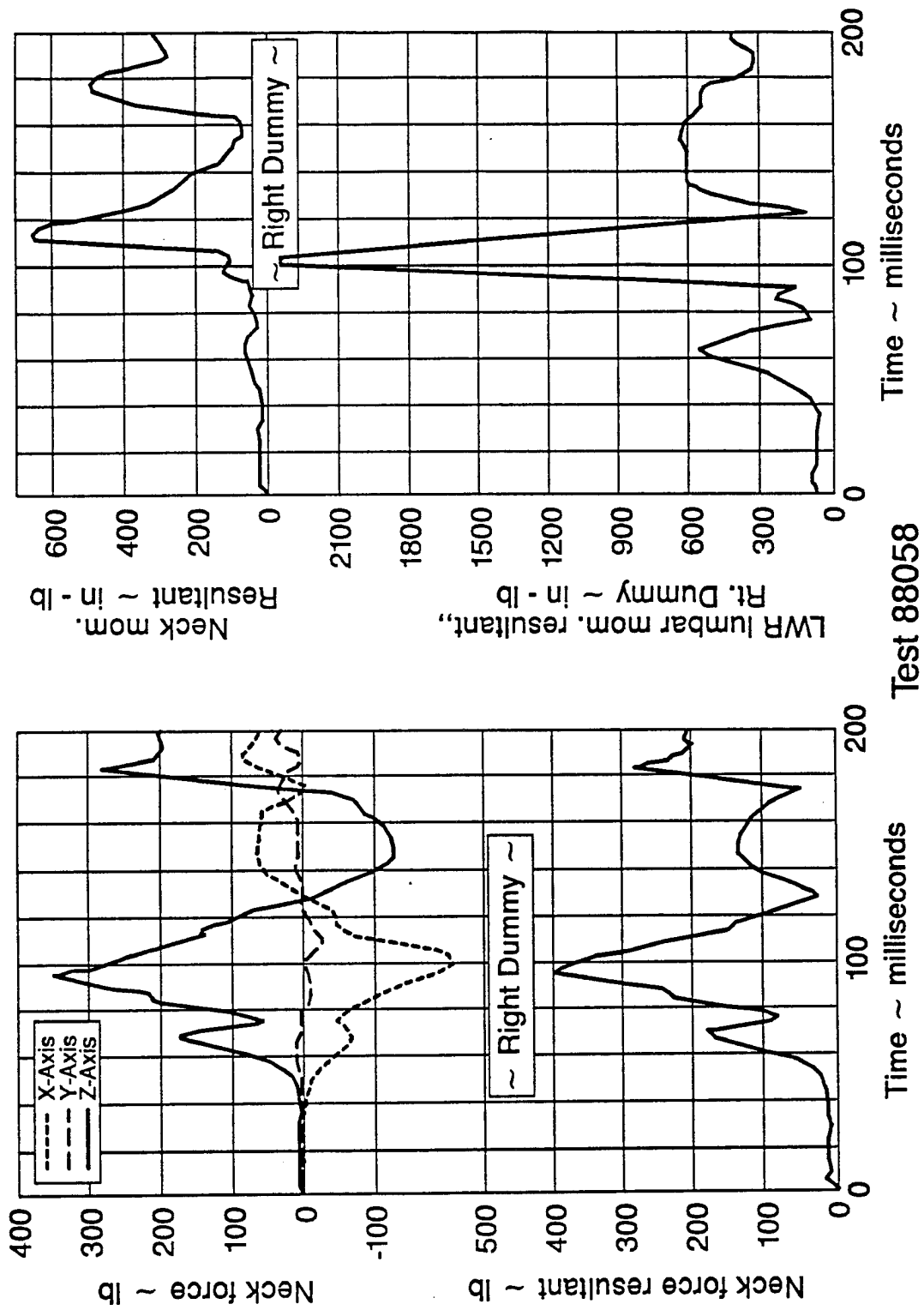

Figure A-7. Neck forces and moments and lower lumbar resultant moment, right dummy, test 88058.

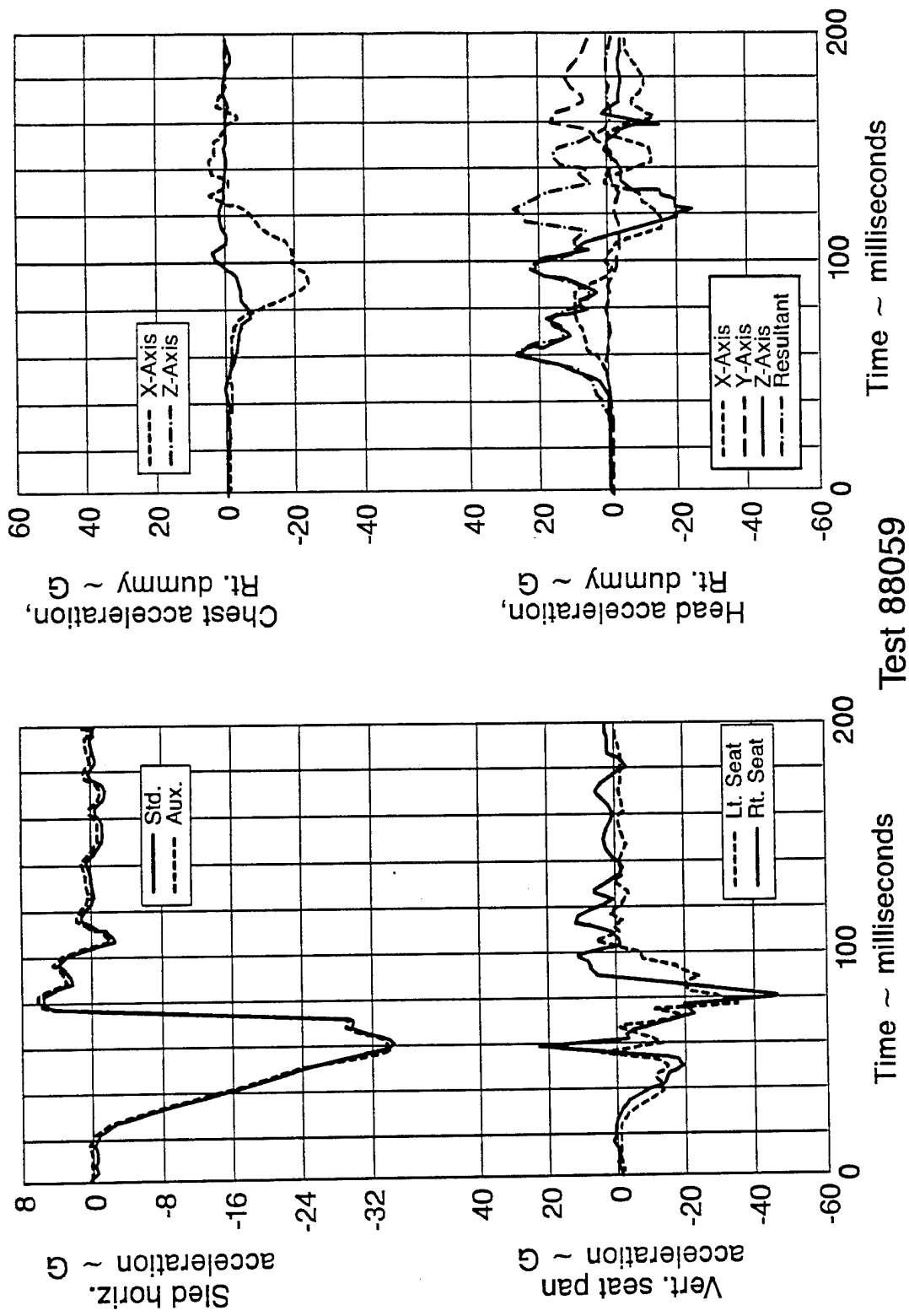
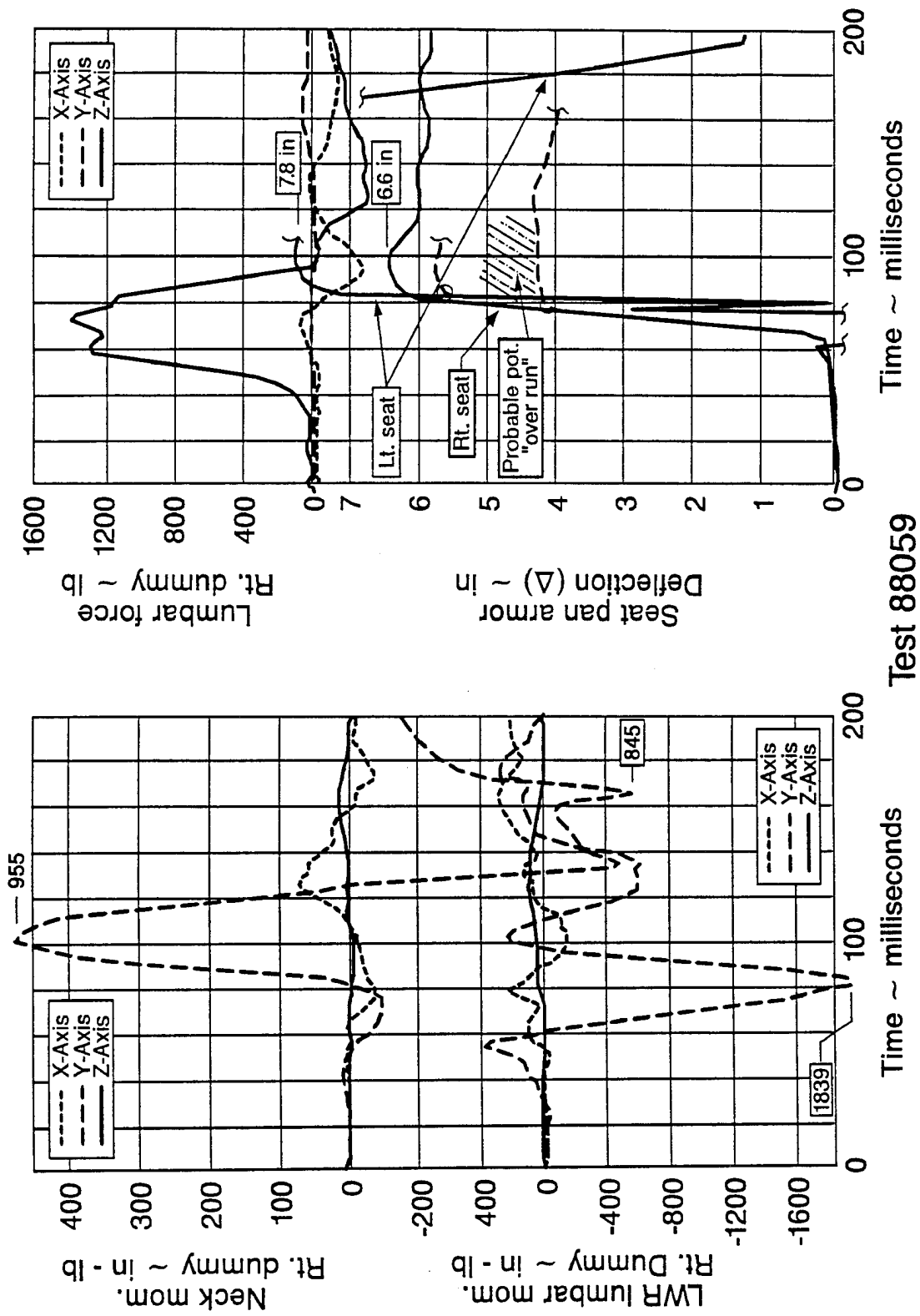

Figure A-8. Sled, seat, and right dummy acceleration traces.



Test 88059

Figure A-9. Seat pan deflection and right dummy neck and lumbar force/moment.

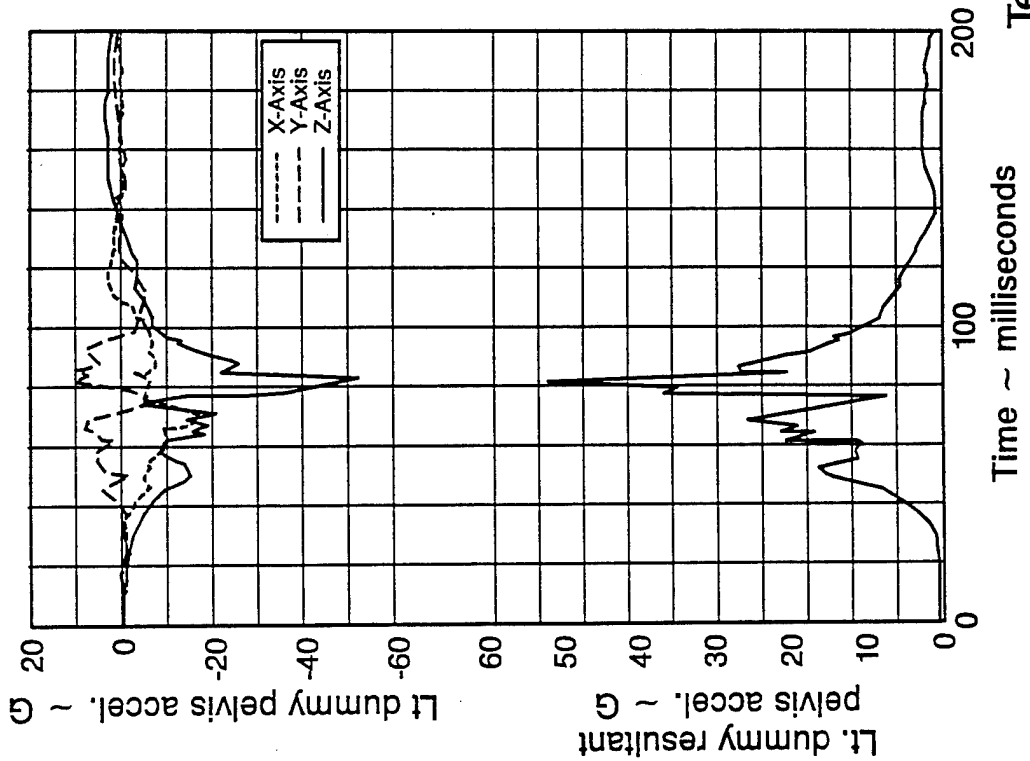
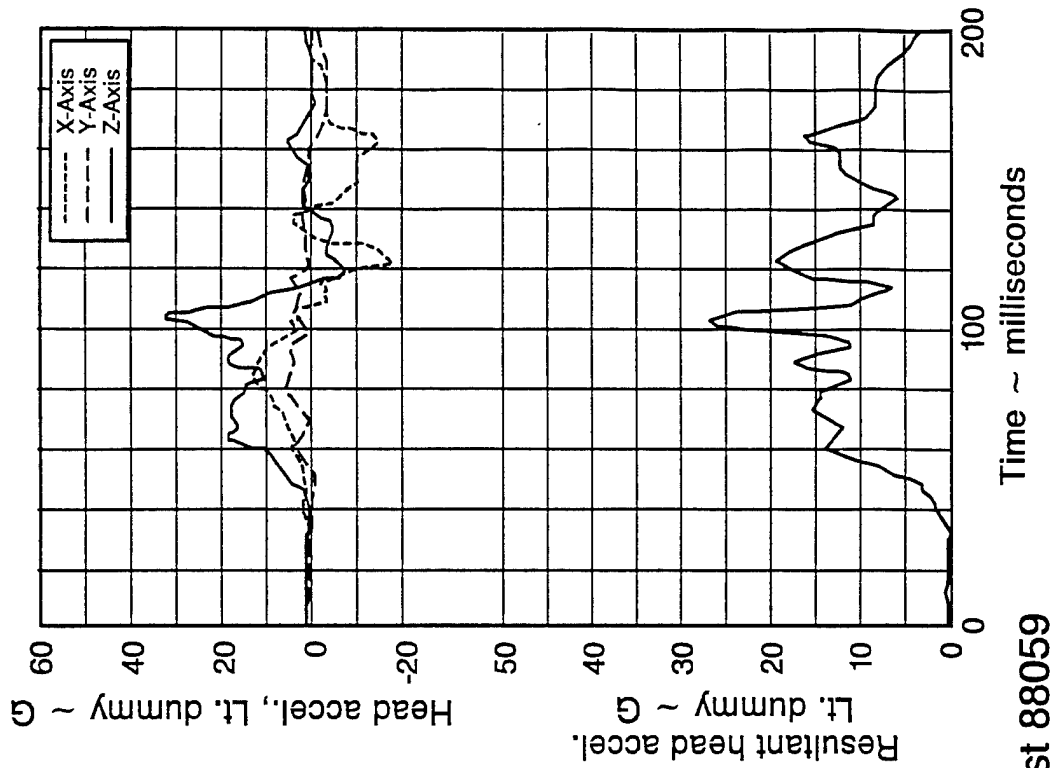

Figure A-10. Head and pelvis accelerations of left dummy.

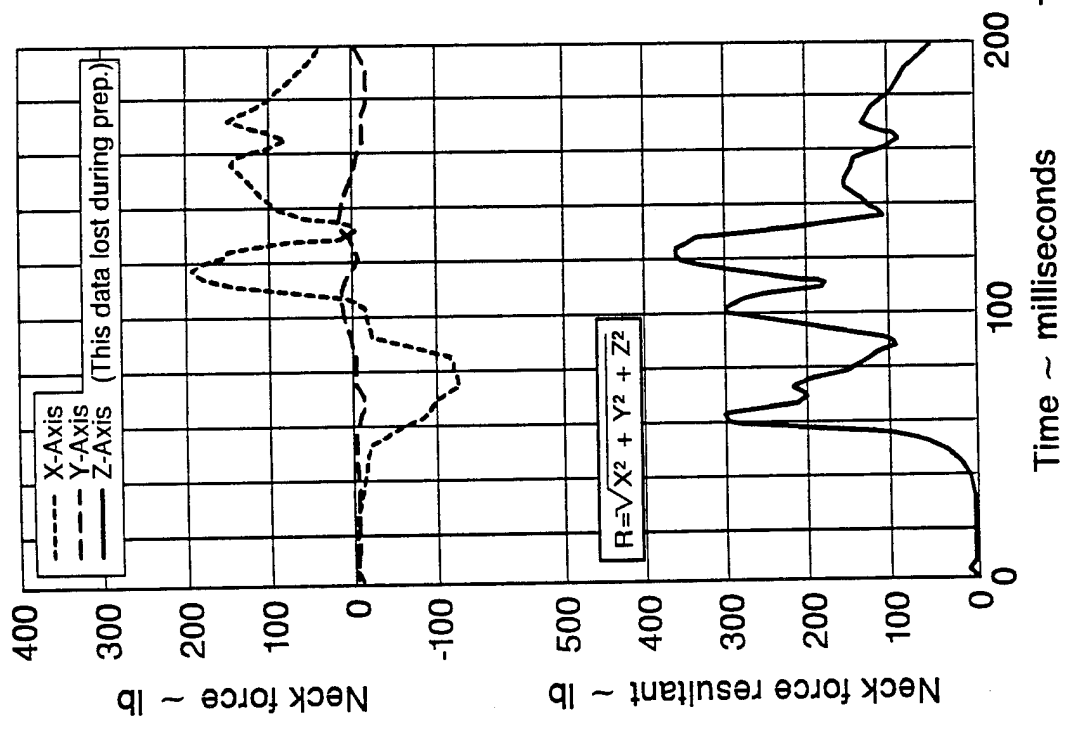
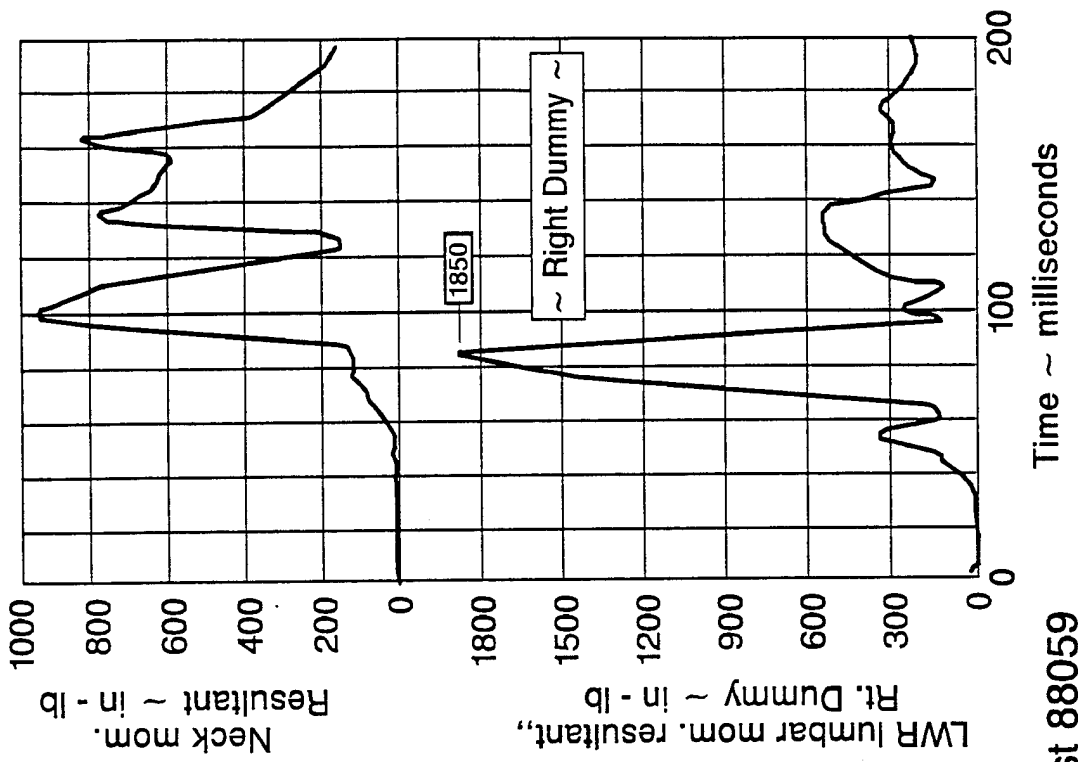

Figure A-11. Neck forces and moments and lower lumbar resultant moment for right dummy.

Appendix B.

List of Bell Helicopter Textron (BHT) engineering drawings
used in the design, construction, and retrofit of
OH-58 pilot and copilot seats.

BHT drawing numbers	Drawing title
206-078-386	Modified, crew seat, airframe and controls (top drawing)
206-801-304	Details, collective friction (three items, -101, -105, and -107)
206-801-305	Installation, collective controls
206-830-335	Installation, airframe structure (16 items)
206-830-336	Plate, pilot's (20 items, -103 through -139)
206-830-337	Strut assembly (bracing tube assembly, four items)
206-830-338	Test fixture installation (13 items, installs cockpit structure)
206-078-375	Energy absorber assembly (four items, -109, -111, -115, and -119)
206-078-376	Cushion assembly, seat and back (14 items, -103 through -131)
206-078-377	Rebound assembly (three items)
206-078-378	Hook support assembly, forward/lateral (two items)
206-078-379	Closure installation, crew seat
206-078-380	Frame assembly
206-078-381	Side rail, frame structure (six items)
206-078-382	Aft cross member, frame structure (two items)
206-078-383	Forward cross member, frame structure (two items)
206-078-384	Upper/lower panel, frame structure (four items)
206-078-385	Hinge assembly, lap belt attachment (four items)
206-078-386	Top drawing, see above
206-078-387	Rebound bracket, frame structure (two items)
206-078-388	Support hook, forward/lateral (four items)
206-078-389	Armor modification, pilot and copilot seat
206-078-390	Crewseat modification (shows seat assembly and installation)

Appendix C.

TECOM reprint

Section 1. Executive Digest (from TECOM #4-AI-130-58A-023)

1.1 TEST OBJECTIVE

To assess compatibility, pilot comfort, and structural integrity of the crashworthy seat and 5-point restraint system in OH-58 aircraft.

1.2 TESTING AUTHORITY

On 9 September 1988, U.S. Army Aeromedical Research Laboratory (USAARL) requested U.S. Army Test and Evaluation Command (TECOM) conduct a suitability test of the new OH-58 load-limiting crashworthy pilot's seat and 5-point restraint system (reference (ref) 3.4.1). On 14 October 1988, TECOM directed U.S. Army Aviation Development Test Activity (USAAVNDTA) to conduct the test (ref 3.4.2).

1.3 SCOPE

1.3.1 USAAVNDTA conducted the test from 9 through 30 January 1989 in the vicinity of Fort Rucker, Alabama. USAARL provided JOH-58A, Army serial number (ASN) 71-20778, with the crashworthy seats and restraint systems installed. Updated weight and balance forms were provided by USAARL. Test findings were submitted to USAARL in summary test incident report (TIR) format on 30 January 1989.

1.3.2 The test items were flown a total of 50 hours by 10 pilots. The sponsor funded 10 additional flight hours for currency requirements of the pilot-in-command (PIC) test participant.

1.3.3 The project pilot flew from the pilot's seat (equipped with crashworthy seat and standard MA-6 inertia reel) as PIC on all flights. Test participants flew from the copilot's seat (equipped with crashworthy seat and 5-point restraint system). Three of the participants flew with the standard MA-6 inertia reel and seven with the MA-10 dual mode inertia reel.

1.4 MATERIEL DESCRIPTION

1.4.1 The crashworthy seat (figure (fig) 1) uses a new thin cushion similar to the AH-1S survivability and vulnerability improvement modifications (SAVIM) seat. This is a plastic lever suspension system that provides uniform loading. This thin cushion allows the seat pan to be located less than an inch (2.54 centimeters (cm)) away from the occupant's buttocks on the AH-1S SAVIM energy attenuating seat with a sheepskin cover. On the OH-58 energy attenuating seat, more plastic lever stages are used and a breathable cushion cover was added. Under 1 G load, the OH-58 occupant buttocks-to-seat-pan- distance is 1.5 inches (3.8 cm). The structural honeycomb panel under the seat cushion was replaced by the armor panel. A frame is built up around the edges of the armor to enclose the armor in the panel. The pilot armor plate is retained.

1.4.2 The 5-point restraint system (fig 1) is a standard harness with rotary buckle presently configured for the UH-60 and AH-64 aircraft. The belt webbing is made of polyester, is 1.75 inches wide, and has a minimum tensile strength of 2,500 pounds.

1.4.3 The pilot's station consisted of standard Pacific Scientific model MA-6 (set to lock at 2.5 G's) on all flights.

1.4.4 Two configuration of restraint systems were used at the copilot station, Pacific Scientific model MA-6 (set to lock at 2.5 G's), and MA-10 dual mode inertia reel (set to lock at 1.5 G's) which operates from strap and vehicle acceleration.

1.5 SUMMARY

a. Ground tests consisted of display and control read/manipulation, anthropometry/ergonomic assessment, emergency egress tests, and seat sag tests.

b. Flight testing consisted of standard maneuvers during nap-of-the- earth (NOE), navigational, and mission oriented flights.

c. Results were:

- (1) All participants were able to fly the aircraft to ATM standards on all flight segments.
- (2) Egress times for personnel clad in MOPP4 and M43 mask ranged from 5.1 to 14.6 seconds.
- (3) No unusual seat vibration was detected (with/without night vision goggles (NVG's)).
- (4) No thermal problems were reported.
- (5) No compatibility problems were found or reported after changes to the seat/restraint system were implemented. Changes included shortening the shoulder harness, moving the crotch harness inboard, decreasing the width of the seat pad, and raising the inertia reel control 3/4 inch.
- (6) The seat was rated better than the standard seat in comfort and highly commended by the participants for its fatigue reducing design.
- (7) No problems were reported with either the MA-6 or the MA-10 inertia reel.



Figure C-1. The crashworthy seat and five-point restraint system (from TECOM #4AI-130-58A-023).

Initial distribution

Commander, U.S. Army Natick Research,
Development and Engineering Center
ATTN: SATNC-MIL (Documents
Librarian)
Natick, MA 01760-5040

Chairman
National Transportation Safety Board
800 Independence Avenue, S.W.
Washington, DC 20594

Commander
10th Medical Laboratory
ATTN: Audiologist
APO New York 09180

Naval Air Development Center
Technical Information Division
Technical Support Detachment
Warminster, PA 18974

Commanding Officer, Naval Medical
Research and Development Command
National Naval Medical Center
Bethesda, MD 20814-5044

Deputy Director, Defense Research
and Engineering
ATTN: Military Assistant
for Medical and Life Sciences
Washington, DC 20301-3080

Commander, U.S. Army Research
Institute of Environmental Medicine
Natick, MA 01760

Library
Naval Submarine Medical Research Lab
Box 900, Naval Sub Base
Groton, CT 06349-5900

Executive Director, U.S. Army Human
Research and Engineering Directorate
ATTN: Technical Library
Aberdeen Proving Ground, MD 21005

Commander
Man-Machine Integration System
Code 602
Naval Air Development Center
Warminster, PA 18974

Commander
Naval Air Development Center
ATTN: Code 602-B
Warminster, PA 18974

Commanding Officer
Armstrong Laboratory
Wright-Patterson
Air Force Base, OH 45433-6573

Director
Army Audiology and Speech Center
Walter Reed Army Medical Center
Washington, DC 20307-5001

Commander/Director
U.S. Army Combat Surveillance
and Target Acquisition Lab
ATTN: SFAE-IEW-JS
Fort Monmouth, NJ 07703-5305

Director
Federal Aviation Administration
FAA Technical Center
Atlantic City, NJ 08405

Director
Walter Reed Army Institute of Research
Washington, DC 20307-5100

Commander, U.S. Army Test
and Evaluation Command
Directorate for Test and Evaluation
ATTN: AMSTE-TA-M (Human Factors
Group)
Aberdeen Proving Ground,
MD 21005-5055

Naval Air Systems Command
Technical Air Library 950D
Room 278, Jefferson Plaza II
Department of the Navy
Washington, DC 20361

Director
U.S. Army Ballistic
Research Laboratory
ATTN: DRXBR-OD-ST Tech Reports
Aberdeen Proving Ground, MD 21005

Commander
U.S. Army Medical Research
Institute of Chemical Defense
ATTN: SGRD-UV-AO
Aberdeen Proving Ground,
MD 21010-5425

Commander
USAMRMC
ATTN: SGRD-RMS
Fort Detrick, Frederick, MD 21702-5012

HQ DA (DASG-PSP-O)
5109 Leesburg Pike
Falls Church, VA 22041-3258

Harry Diamond Laboratories
ATTN: Technical Information Branch
2800 Powder Mill Road
Adelphi, MD 20783-1197

U.S. Army Materiel Systems
Analysis Agency
ATTN: AMXSU-PA (Reports Processing)
Aberdeen Proving Ground
MD 21005-5071

U.S. Army Ordnance Center
and School Library
Simpson Hall, Building 3071
Aberdeen Proving Ground, MD 21005

U.S. Army Environmental
Hygiene Agency
ATTN: HSHB-MO-A
Aberdeen Proving Ground, MD 21010

Technical Library Chemical Research
and Development Center
Aberdeen Proving Ground, MD
21010-5423

Commander
U.S. Army Medical Research
Institute of Infectious Disease
ATTN: SGRD-UIZ-C
Fort Detrick, Frederick, MD 21702

Director, Biological
Sciences Division
Office of Naval Research
600 North Quincy Street
Arlington, VA 22217

Commandant
U.S. Army Aviation
Logistics School ATTN: ATSQ-TDN
Fort Eustis, VA 23604

Headquarters (ATMD)
U.S. Army Training
and Doctrine Command
ATTN: ATBO-M
Fort Monroe, VA 23651

IAF Liaison Officer for Safety
USAF Safety Agency/SEFF
9750 Avenue G, SE
Kirtland Air Force Base
NM 87117-5671

Naval Aerospace Medical
Institute Library
Building 1953, Code 03L
Pensacola, FL 32508-5600

Command Surgeon
HQ USCENCOM (CCSG)
U.S. Central Command
MacDill Air Force Base, FL 33608

Director
Directorate of Combat Developments
ATTN: ATZQ-CD
Building 515
Fort Rucker, AL 36362

U.S. Air Force Institute
of Technology (AFIT/LDEE)
Building 640, Area B
Wright-Patterson
Air Force Base, OH 45433

Henry L. Taylor
Director, Institute of Aviation
University of Illinois-Willard Airport
Savoy, IL 61874

Chief, National Guard Bureau
ATTN: NGB-ARS
Arlington Hall Station
111 South George Mason Drive
Arlington, VA 22204-1382

AAMRL/HEX
Wright-Patterson
Air Force Base, OH 45433

Commander
U.S. Army Aviation and Troop Command
ATTN: AMSAT-R-ES
4300 Goodfellow Bouvelard
St. Louis, MO 63120-1798

U.S. Army Aviation and Troop Command
Library and Information Center Branch
ATTN: AMSAV-DIL
4300 Goodfellow Boulevard
St. Louis, MO 63120

Federal Aviation Administration
Civil Aeromedical Institute
Library AAM-400A
P.O. Box 25082
Oklahoma City, OK 73125

Commander
U.S. Army Medical Department
and School
ATTN: Library
Fort Sam Houston, TX 78234

Commander
U.S. Army Institute of Surgical Research
ATTN: SGRD-USM
Fort Sam Houston, TX 78234-6200

Air University Library
(AUL/LSE)
Maxwell Air Force Base, AL 36112

Product Manager
Aviation Life Support Equipment
ATTN: SFAE-AV-LSE
4300 Goodfellow Boulevard
St. Louis, MO 63120-1798

Commander and Director
USAE Waterways Experiment Station
ATTN: CEWES-IM-MI-R,
CD Department
3909 Halls Ferry Road
Vicksburg, MS 39180-6199

Commanding Officer
Naval Biodynamics Laboratory
P.O. Box 24907
New Orleans, LA 70189-0407

Assistant Commandant
U.S. Army Field Artillery School
ATTN: Morris Swott Technical Library
Fort Sill, OK 73503-0312

Mr. Peter Seib
Human Engineering Crew Station
Box 266
Westland Helicopters Limited
Yeovil, Somerset BA20 2YB UK

U.S. Army Dugway Proving Ground
Technical Library, Building 5330
Dugway, UT 84022

U.S. Army Yuma Proving Ground
Technical Library
Yuma, AZ 85364

AFFTC Technical Library
6510 TW/TSTL
Edwards Air Force Base,
CA 93523-5000

Commander
Code 3431
Naval Weapons Center
China Lake, CA 93555

Aeromechanics Laboratory
U.S. Army Research and Technical Labs
Ames Research Center, M/S 215-1
Moffett Field, CA 94035

Sixth U.S. Army
ATTN: SMA
Presidio of San Francisco, CA 94129

Commander
U.S. Army Aeromedical Center
Fort Rucker, AL 36362

Strughold Aeromedical Library
Document Service Section
2511 Kennedy Circle
Brooks Air Force Base, TX 78235-5122

Dr. Diane Damos
Department of Human Factors
ISSM, USC
Los Angeles, CA 90089-0021

U.S. Army White Sands
Missile Range
ATTN: STEWS-IM-ST
White Sands Missile Range, NM 88002

Director, Airworthiness Qualification Test
Directorate (ATTC)
ATTN: STEAT-AQ-O-TR (Tech Lib)
75 North Flightline Road
Edwards Air Force Base, CA 93523-6100

Ms. Sandra G. Hart
Ames Research Center
MS 262-3
Moffett Field, CA 94035

Commander
USAMRMC
ATTN: SGRD-UMZ
Fort Detrick, Frederick, MD 21702-5009

Commander
U.S. Army Health Services Command
ATTN: HSOP-SO
Fort Sam Houston, TX 78234-6000

U. S. Army Research Institute
Aviation R&D Activity
ATTN: PERI-IR
Fort Rucker, AL 36362

Commander
U.S. Army Safety Center
Fort Rucker, AL 36362

U.S. Army Aircraft Development
Test Activity
ATTN: STEBG-MP-P
Cairns Army Air Field
Fort Rucker, AL 36362

Commander
USAMRMC
ATTN: SGRD-PLC (COL R. Gifford)
Fort Detrick, Frederick, MD 21702

TRADOC Aviation LO
Unit 21551, Box A-209-A
APO AE 09777

Netherlands Army Liaison Office
Building 602
Fort Rucker, AL 36362

British Army Liaison Office
Building 602
Fort Rucker, AL 36362

Italian Army Liaison Office
Building 602
Fort Rucker, AL 36362

Directorate of Training Development
Building 502
Fort Rucker, AL 36362

Chief
USAHEL/USAAVNC Field Office
P. O. Box 716
Fort Rucker, AL 36362-5349

Commander, U.S. Army Aviation Center
and Fort Rucker
ATTN: ATZQ-CG
Fort Rucker, AL 36362

Dr. Sehchang Hah
Dept. of Behavior Sciences and
Leadership, Building 601, Room 281
U. S. Military Academy
West Point, NY 10996-1784

Canadian Army Liaison Office
Building 602
Fort Rucker, AL 36362

German Army Liaison Office
Building 602
Fort Rucker, AL 36362

French Army Liaison Office
USAAVNC (Building 602)
Fort Rucker, AL 36362-5021

Australian Army Liaison Office
Building 602
Fort Rucker, AL 36362

Dr. Garrison Rapmund
6 Burning Tree Court
Bethesda, MD 20817

Commandant, Royal Air Force
Institute of Aviation Medicine
Farnborough, Hampshire GU14 6SZ UK

Defense Technical Information
Cameron Station, Building 5
Alexandra, VA 22304-6145

Commander, U.S. Army Foreign Science
and Technology Center
AIFRTA (Davis)
220 7th Street, NE
Charlottesville, VA 22901-5396

Commander
Applied Technology Laboratory
USARTL-ATCOM
ATTN: Library, Building 401
Fort Eustis, VA 23604

Commander, U.S. Air Force
Development Test Center
101 West D Avenue, Suite 117
Eglin Air Force Base, FL 32542-5495

Aviation Medicine Clinic
TMC #22, SAAF
Fort Bragg, NC 28305

Dr. H. Dix Christensen
Bio-Medical Science Building, Room 753
Post Office Box 26901
Oklahoma City, OK 73190

Commander, U.S. Army Missile
Command
Redstone Scientific Information Center
ATTN: AMSMI-RD-CS-R
/ILL Documents
Redstone Arsenal, AL 35898

Aerospace Medicine Team
HQ ACC/SGST3
162 Dodd Boulevard, Suite 100
Langley Air Force Base,
VA 23665-1995

U.S. Army Research and Technology
Laboratories (AVSCOM)
Propulsion Laboratory MS 302-2
NASA Lewis Research Center
Cleveland, OH 44135

Commander
USAMRMC
ATTN: SGRD-ZC (COL John F. Glenn)
Fort Detrick, Frederick, MD 21702-5012

Dr. Eugene S. Channing
166 Baughman's Lane
Frederick, MD 21702-4083

U.S. Army Medical Department
and School
USAMRDALC Liaison
ATTN: HSMC-FR
Fort Sam Houston, TX 78234

NVESD
AMSEL-RD-NV-ASID-PST
(Attn: Trang Bui)
10221 Burbeck Road
Fort Belvoir, VA 22060-5806

CA Av Med
HQ DAAC
Middle Wallop
Stockbridge, Hants S020 8DY UK

Dr. Christine Schlichting
Behavioral Sciences Department
Box 900, NAVUBASE NLON
Groton, CT 06349-5900

Commander
Aviation Applied Technology Directorate
ATTN: AMSAT-R-TV
Fort Eustis, VA 23604-5577

COL Yehezkel G. Caine, MD
Surgeon General, Israel Air Force
Aeromedical Center Library
P. O. Box 02166 I.D.F.
Israel

HQ ACC/DOHP
205 Dodd Boulevard, Suite 101
Langley Air Force Base,
VA 23665-2789

41st Rescue Squadron
41st RQS/SG
940 Range Road
Patrick Air Force Base,
FL 32925-5001

48th Rescue Squadron
48th RQS/SG
801 Dezonias Road
Holloman Air Force Base,
NM 88330-7715

HQ, AFOMA
ATTN: SGPA (Aerospace Medicine)
Bolling Air Force Base,
Washington, DC 20332-6128

ARNG Readiness Center
ATTN: NGB-AVN-OP
Arlington Hall Station
111 South George Mason Drive
Arlington, VA 22204-1382

35th Fighter Wing
35th FW/SG
PSC 1013
APO AE 09725-2055

66th Rescue Squadron
66th RQS/SG
4345 Tyndall Avenue
Nellis Air Force Base, NV 89191-6076

71st Rescue Squadron
71st RQS/SG
1139 Redstone Road
Patrick Air Force Base,
FL 32925-5000

Director
Aviation Research, Development
and Engineering Center
ATTN: AMSAT-R-Z
4300 Goodfellow Boulevard
St. Louis, MO 63120-1798

Commander
USAMRMC
ATTN: SGRD-ZB (COL C. Fred Tyner)
Fort Detrick, Frederick, MD 21702-5012

Commandant
U.S. Army Command and General Staff
College
ATTN: ATZL-SWS-L
Fort Leavenworth, KS 66027-6900

ARNG Readiness Center
ATTN: NGB-AVN-OP
Arlington Hall Station
111 South George Mason Drive
Arlington, VA 22204-1382

Director
Army Personnel Research Establishment
Farnborough, Hants GU14 6SZ UK

Dr. A. Kornfield
895 Head Street
San Francisco, CA 94132-2813

ARNG Readiness Center
ATTN: NGB-AVN-OP
Arlington Hall Station
111 South George Mason Drive
Arlington, VA 22204-1382

Cdr, PERSCOM
ATTN: TAPC-PLA
200 Stovall Street, Rm 3N25
Alexandria, VA 22332-0413

HQ, AFOMA
ATTN; SGPA (Aerospace Medicine)
Bolling Air Force Base,
Washington, DC 20332-6188